

QV400D

SOUND DEVELOPMENT AND
PROGRAMMING TOOL



USER'S GUIDE

V1.10

Quadravox, Inc

Quadravox

Table of Contents

CHAPTER 1

PRODUCT OVERVIEW	9
<i>Overview</i>	9
<i>Feature List</i>	9

CHAPTER 2

GETTING STARTED / INSTALLATION	10
<i>Minimum System Requirement</i>	10
<i>Minimum Kit Contents</i>	10
<i>Software Installation</i>	10
<i>Hardware Installation</i>	10
<i>QV400D Upgrade</i>	11
<i>Kit Contents</i>	11
<i>Installation</i>	11

CHAPTER 3

PROGRAMMER HARDWARE	13
QV400D BOARD	13
<i>Power Supply</i>	15
<i>Socket Adapters</i>	15

CHAPTER 4

QV400S :QUADRAVOX UNIVERSAL SPEECH TOOLS	16
<i>Overview</i>	16
<i>Opening Window</i>	16
Project Menu	16
Options Menu.....	16
Window Menu	16
Help Menu	16
<i>Frame Window Icons</i>	17
<i>General Organization</i>	17

CHAPTER 4 : SECTION A

QV400S : PROJECT WINDOW	18
<i>Project Menu</i>	18
Add Files.....	18
Save	18
Save as.....	18
Close	18
Select Entire Project	18
Unselect all	18
Record a new file (see wave file recording below)	18
Delete files	18
Open Concatenation Window (see Concatenation Window below).....	18
Refresh all windows.....	18
<i>Options Menu</i>	19
Preferences.....	19
Expand.....	19

Collapse	19
Wav Play Menu	19
Selected phrases in project.....	19
Selected Concatenation.....	19
All concatenations containing selected phrases.....	19
Selected Concatenation with insertion (see Play with Insertion below).....	19
Sys Play Menu	19
Selected Phrases in project.....	19
Selected Concatenation.....	19
All concatenations containing selected phrase.....	19
Selected Concatenation with insertion	19
Variable Menu	19
Window Menu	19
Cascade.....	19
Tile Horizontal	19
Tile Vertical.....	19
Arrange Icons.....	19
Close All.....	19
Help Menu	19
File Manipulation	20
Select File.....	20
Unselect File.....	20
Remove File.....	20
Reinstate file.....	20
File Info.....	20
Insert File.....	20
Edit File (see Wav file Editing below).....	20
Play With Insertion.....	21
Information Window Menu	21
Add Concatenation	21
CHAPTER 4: SECTION B	
QV400S : CONCATENATION WINDOW	22
Concatenation Menu	22
Add Concatenation	22
Delete Concatenation	22
Copy Concatenation	22
Paste Concatenation	22
Insert First Highlighted phrase.....	22
Insert every phrase	22
Insert All Phrases.....	22
Change Name	22
Delete all concatenations	22
Create Concatenations from Text (see Create Concat from Text below).....	22
Options Menu	23
Preferences	23
Expand.....	23
Collapse.....	23
Wav Play Menu	23
Selected Phrases in Project	23
Selected Concatenation.....	23
All Concatenations containing selected phrase.....	23
Selected Concatenation with insertion (see Play with insertion below).....	23
Sys Play Menu	23
Selected Phrases in Project	23
Selected Concatenation.....	23
All Concatenations containing selected phrase.....	23

Selected Concatenation with insertion	23
Variable Menu	23
Window Menu	23
Cascade.....	23
Tile Horizontal	23
Tile Vertical.....	23
Arrange Icons.....	23
Close all.....	23
Help Menu	23
Create Concatenations from Text	25
Text File	25
Concatenation Name Generated.....	25
Concatenation name from Phrase.....	25
OK, Cancel, Help	25
ASCII Text File : Phrase file to generate concatenation from text	26
CHAPTER 4 : SECTION C	
QV400S : WAV FILE EDITING	27
File Menu	27
Save.....	27
Save as.....	27
Save Selection	27
Exit	27
Play Menu	27
Play Selected.....	27
Play Whole	27
Play Left.....	27
Play Right.....	27
Window Menu	27
The Icon Bar	28
Undo Last Operation	28
Cut.....	28
Copy.....	28
Paste.....	28
Increase Vertical	28
Decrease Vertical Scale	28
Zoom In	28
Zoom Out	28
The Signal Window	28
The Information Line	28
Total.....	28
Screen.....	28
Select	28
Cursor	28
CHAPTER 4: SECTION D	
QV400S : WAV FILE RECORDING	29
Wav Device Status	29
Elapsed Time	29
Record	29
Stop.....	29
Playback	29
Save File.....	29
Record Setting.....	29
Input Device	29
Volume	29
Parameters.....	29
OK.....	29

CHAPTER 5

UNIVERSAL SPEECH TOOLS : ISD PROGRAMMING	30
<i>Overview</i>	30
<i>First Time Run</i>	30
<i>Project Open Dialg</i>	31
ISD System Selection.....	31
ISD Chip Selection.....	31
Multi Chip Support.....	31
<i>Project Window Display</i>	32
Project Name.....	32
Current Chip.....	32
Asterisk.....	32
File Selected.....	32
File Removed.....	32
Label.....	32
Duration.....	32
Frequency / Date.....	32
Insertion Column.....	32
Addresses.....	33
Free Address.....	33
Fix Address.....	33
Free AllAddresses.....	33
Fix All Addresses.....	33
Toggle Hexadecimal / Decimal Display.....	33
<i>Concatenation Window Display</i>	34
Concatenation Name.....	34
Concatenation Elements.....	34
Concatenation Element Label.....	34
Concatenation Selected.....	34
Phrase Selected in Concatenation.....	34
Duration of Concatenation and Elements.....	34
<i>Information Window Display</i>	35
Chip Type and Duration.....	35
Project Duration and Chip utilization.....	35
Number of files in the project used in concatenation.....	35
<i>ISD Chip Reference</i>	36
List of ISD chips supported by QV400D.....	36
Chip Name.....	36
Sampling Frequency.....	36
Duration.....	36
Granularity.....	36
ISD1500 Adapter.....	37
ISD1600 Adapter.....	37
ISD5008 Adapter.....	37
<i>The Program Menu</i>	38
Manual.....	38
Automatic.....	38
Files at fixed address.....	38
All other files.....	38
Fix All Addresses.....	38
Free AllAddresses.....	38
Setup (see Parameters Dialog box below).....	38
Reset.....	38
Create Table (see Create Table Dialog below).....	38
Import iQbox Project.....	38
<i>Create Table Dialog</i>	39
From Project.....	39
From Wav Files.....	39

For QV4xxP Gang Programmers	39
Delimiting Character	39
Concat String	39
End of Concat String	39
Constant String	39
Advanced C Format.....	39
OK / Cancel / Help	39
Example of Address Table.....	40
With Bracket Delimiter.....	40
With Comma Delimiter.....	42
Example of C Table	43
Table Preparation for QV4xxP Gang Programmers.....	43
Parameters Dialog	44
System Name.....	44
Epsilon1 and Epsilon2.....	44
Control Frequency	44
Recording Level	44
Control Level	45
Ramp Up	45
Ramp Down.....	45
Switch Channels	45
Changing the ISD chip in a Project	45
CHAPTER 6	
SAMPLE PROJECT FOR QV400S.EXE AND ISD CHIPS	46
Overview.....	46
Open New Project.....	47
Adding Files to a Project.....	48
Inserting Concatenation.....	49
Inserting Phrases.....	50
Playing Concatenations.....	52
ISD Recording.....	53
Playback from Chip.....	54
Fast Track Sample project Tutorial	55
CHAPTER 7	
VOCABULARY LIBRARY	57
Application Specific List of Vocabulary.....	57
Alphabets :English and Military.....	57
Numbers.....	58
Time and Date.....	58
Telephone.....	58
Home Automation.....	59
Instrumentation.....	60
Alphabetical List of Vocabulary	61
CHAPTER 8	
ERROR AND WARNING MESSAGES	64
Initialization File.....	66
CHAPTER 9	
TROUBLESHOOTING AND TECHNICAL SUPPORT.....	67
CHAPTER 10	
TERMS AND CONDITIONS	69
Limited Warranty	69

Software License Agreement..... 70
Disclaimer and Copyright Notice..... 70

APPENDIX A.

WORLDWIDE DISTRIBUTORS 71

Information in this document is subject to change without notice and does not represent a commitment on the part of Quadravox, Inc. No part of this document may be reproduced in any form without the prior written consent of Quadravox, Inc.

For details on Warranty and Software License, see chapter 10.

Second Edition
February, 2000

© 1999,2000 [Quadravox, Inc.](#) All rights reserved.

Quadravox, QV400S, QV400D and **iQbox** are trademarks of [Quadravox, Inc.](#)

Windows 3.1, Windows 95, Windows 98 and **Windows NT** are registered trademarks of Microsoft Corporation, Inc.

ISD and **ChipCorder** are registered trademarks of **Information Storage Devices, Inc.**

All other product names mentioned are either trademarks or registered trademarks of their respective companies

Quadravox

Chapter 1. Product Overview

Overview

Quadravox's QV400D provides all the software and hardware functions needed to develop complex messaging systems using ISD's ChipCorder family of analog recording devices

QV400D supports all current ISD ChipCorder devices in 28-pin DIP package.

- ISD1500 and ISD1600 series devices require socket adapters (QV400D-01 & QV400D-02)
- ISD5008 series devices require socket adapter (QV400D-3A or QV400D-3B)
- Socket Adapters are available for devices in SOIC or TSOP packages.

QV400S™ is a software package designed to unify the interface to various speech development systems produced by Quadravox. It consists of one executable file, QV400S0.exe (for Windows 3.11) or QV400S1.exe (for Windows 95 or later), several DLLs (one at least for each development system), several help files, and an initialization file, QV400S0.ini. (Win3.11) or QV400S1.ini (Win95 or later);

Adding the capabilities for a new development system will only require the adjunction of a DLL to the existing software. The user interface, residing in the main executable file, will be unchanged.

The main help only contains the general description of the user interface. Help for the different speech processing systems is context sensitive, and can be accessed when the software is running.

Feature List

- Utilizes standard Windows .wav format files as input.
- Project management software includes message concatenation creation and auditing for building complex, compact, message systems.
- Data are written to precise, pre-computed locations; each programmed device is identical.
- Word and concatenation tables are automatically created. The tables are compatible with Quadravox's gang programmers and can also be used by the customer to create microprocessor look-up tables.
- Simple hookup: a single stereo audio cable carries both signal and controls.

The product consists of :

- QV400D board with sockets for ISD1000-2500 and ISD33000-4003 device families.
- Stereo audio cable
- DC 9V, 300mA power supply (North American or European (500mA)).
- Driver and user interface software compatible with Windows 3.1, WFW, 95, and 98 operating systems.
- 331 word standard vocabulary available free from our web site

Quadravox

Chapter 2. Getting Started / Installation

QV400D Installation

Minimum System Requirements:

- 8 MB Ram (16 MB and up preferred)
- CPU Pentium 66 MHz (90 MHz and up preferred)
- 1.5 MB hard disk space (space for projects is additional)

Minimum Kit contents:

- 1 floppy disk, containing all **QV400D** software and documentation (Help file).
- 1 programmer board, with two empty ZIF sockets
- 1 audio cable (6 ft, shielded, 1/8" stereo miniplug at both ends)
- 2.1mm female plug, center positive (North American or European)
- 1 QV400D User's Guide in PDF format
- Standard Vocabulary (see Chapter 7): Available free from www.quadravox.com/support.htm.

Software Installation

Windows 3.11:

This version is no longer shipped. Customers can download the software from web page www.quadravox.com ("support" section).

Windows 95, Windows 98:

Put the floppy disk in your floppy drive, go to Windows File Manager, and run **Setup.exe** from the floppy. The installation program will prompt the user for a directory name where the software will be installed. All files related to this software will be installed in the same directory, except for the QV400S1.ini file, which will be put in the Windows directory. The installation should take much less than 5 minutes. It creates a Quadravox program group with one icon for QV400S1.exe. Please note that the software can be run without the hardware being present. All the functions, except programming and playback of ISD chips, are accessible.

Hardware Installation:

Disconnect your PC sound card speakers cable from the sound card "Line Out" and plug it in the audio jack J3 on the QV400D programmer board marked **To MM Speaker** (Multi Media Speaker). Connect the supplied audio cable between your PC sound card "Line Out" and the audio jack J2 on QV400D board marked **From Sound Card**. When not used, QV400D will act as a pass through for your PC sound card speakers provided the power supply is connected and the QV400D software is not running. You may also want to connect a local speaker (8 ohm) to the QV400D speaker output jack J4 marked **To Local Speaker**.

WARNING: the ISD33000, 4000 and 5008 series chips cannot drive a speaker directly and are not connected to the Local Speaker jack. You can only listen to the output of those chips on your PC's amplified speakers.

Connect the power supply to your QV400D. If, for some reason, you are not using the power supply shipped with the QV400D, please ensure that the supply used meets the following requirements: 9VDC output, 200 mA minimum current, center positive with a 2.1mm pin diameter.

Run QV400s1.exe from your file manager or from the icon just installed. You can invoke all help files from within QV400SX. Don't hesitate to drop us a line at our web site: www.quadravox.com.

If you want to start with the sample project, see Chapter 6. **Sample Project.**

QV400D Upgrade (for iQbox units purchased before October 1998)**Overview**

Customers who purchased the QV400D (formerly known as iQbox) **before October 1998** and want to program ISD4002, ISD4003, ISD4004 and ISD5008 series chips must purchase the firmware upgrade kit QV400D-UPG.

Quadravox has released a new version of the QV400D firmware (rev: K) to replace the old iQbox firmware (rev: J), and a new software package QV400S (QV400S1 for Windows 95 and later, QV400S0 for Windows 3.11) to replace the iQbox software.

This new firmware / software combination now allows the user to program any ISD ChipCorder Device currently released (Socket adapters are required for the ISD5008, ISD1500 and ISD1600 series).

Kit contents:

- 1 floppy disk, containing all QV400S software
- 1 Microchip PIC16C57 chip with revision K firmware.

You may also have ordered various socket adapters

Installation:

The QV400S software can coexist with the old iQbox software. Their project formats are slightly different, but it is possible to import an existing iQbox project into QV400S. Note that the first time you run QV400S, the system will ask you to enter the "carrier frequency" value into the system. This value can be obtained from the iqbox.ini file in your Windows directory. It is the first number after pre_freq= in the [STEREO] section of iqbox.ini. Alternately, this value can be read by running the iQbox software and invoking the Options/Advanced Parameters Setting menu. The value is on the line marked "frequency", and is typically between 14500 and 16500. This value should also be present in your original invoice.

Improvements over iQbox software :

- 32-bit application
- MDI (Multiple Document Interface) format.
- New ways to listen to selected concatenations.
- better manual recording interface
- Text search function on phrase or concatenation labels.
- automatic generation of concatenations based on phrase labels.
- support for Quadravox gang programmer products

Windows 3.1X installation:

This version is no longer shipped. You can download it from our Web page at www.quadravox.com ("Support" section).

Windows 95 (or later) Installation:

Put the floppy disk in your floppy drive. Go into your Windows file manager, and run setup.exe from the floppy drive. This program will install all necessary files on your hard drive. The installation should take much less than 5 minutes. It creates a Quadravox program group, with one icon for QV400S1.exe

Remove power from your programmer board QV400D (ex-iQbox). Remove the PIC microcontroller (marked U2) from its 28pin socket and replace it with the new revision K version. The notch of the PIC chip should be towards the same end of the board as the release handles for the ISD sockets. It will probably be necessary to gently bend the rows of pins towards each other to allow the chip to fit. Do this against a flat surface such as a desktop.

Connect the power supply to your QV400D.

Run QV400S1.exe from your file manager or from the icon just installed. You can invoke all help files from within QV400S. Enter the frequency value noted above when prompted.

Don't hesitate to drop us a line at our Web site: <http://www.quadravox.com>, in case you experience any problem.

Quadravox

Chapter 3. Programmer Hardware

QV400D Board

The speech data created by the project software may be programmed into any ISD ChipCorder device using the **QV400D Programmer**, which comes in the form of a pre-assembled printed circuit board (PCB). Separate easy-to-use ZIF sockets are provided for the ISD1000-2500 and ISD33000-4000 devices.

In most PC systems, amplified speakers are connected to the sound card line output. The programmer is interposed between the PC line out and amplified speakers. No other connections to the PC are required. The QV400D is designed to pass both channels through when it is not in use, but this feature will function only if the power supply remains connected.

The QV400D hardware installation is simple, but there are several points to be observed to obtain best performance. For more information, see Installation and Troubleshooting

The Diagram and description below show the details of the hardware connections. All connectors and jacks on the programmer board are marked on the PCB to facilitate proper connection.

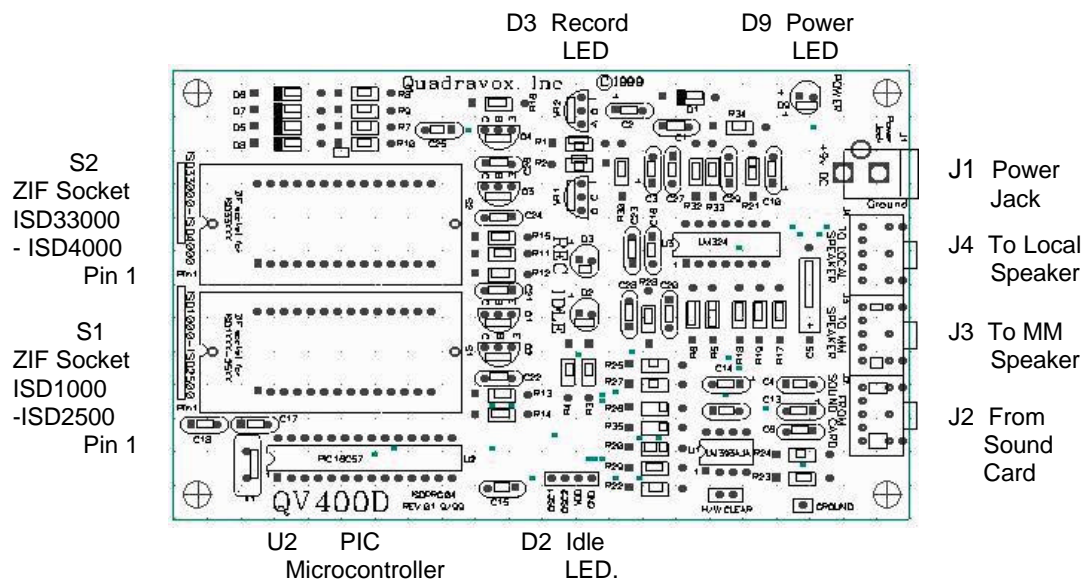

ZIF Socket for ISD1000-ISD2500 series (S1, Marked "ISD1000-ISD2500" on the PCB)

ISD1000, 1100, 1200, 1400 and 2500 series devices in 28/600 mil DIP packages must be plugged in this ZIF socket for programming. Adapter boards QV400D-01 (ISD1500P), QV400D-02 (ISD1600P), QV400D-04 (ISD1100S-2500S) and QV400D-05 (ISD1000G, ISD2500G) must also be plugged into this ZIF socket.

ZIF Socket for ISD33000-ISD4000 series (S2, Marked "ISD33000-ISD4000" on PCB)

ISD33000 and ISD4000 series devices in 28/600 mil DIP packages must be plugged in this ZIF socket for programming. Adapter boards QV400D-3A (ISD5008P), QV400D-3B (ISD5008S), QV400D-06 (ISD33000S-4000S), QV400D-07 (ISD33000E-4000E) and QV400D-08 (ISD3300 or ISD4000 based module) must also be plugged into this ZIF socket.

CAUTION :

- **The notch of the device plugged in the ZIF socket must be towards the same end of the board as the release handles for the ZIF sockets. "Pin-1" is also marked on the board.**
- **It is safe to remove a chip only when the green LED (marked "IDLE") is steady on. The socket is powered down in that condition.**
- **Only one of the two sockets should be occupied at any given time.**

Audio In (Audio Jack J2, marked "**From Sound Card**" on the PCB)

Sound from PC sound card (line out) arrives here. Connect the supplied audio cable in this jack and connect the other end of the cable to the PC sound card "Line Out".

Audio Out (Audio Jack J3, marked "**To MM Speaker**" on the PCB)

Feedback to PC sound card speakers. When QV400D is not in use, it acts as a pass-through for the sound from the PC card if the power supply is connected

Speaker Out (Audio Jack J4, marked "**To Local Speaker**" on the PCB)

Connect an 8 ohm speaker here, using RCA miniature phone plug (1/8" monaural), to listen to the output of the chip. Note that the ISD33000 and 4000 series chips cannot drive a speaker directly: you can listen to the output of the chip on your PC sound card, by connecting the "To MM speaker" output to your PC speakers. Although the ISD5008 has the ability to drive a speaker, in this system the line level audio out pin is used, so it too must be heard through the PC speakers.

Power (Power Jack J1, marked "**Power Jack**" on the PCB)

Power supply connected here; 9VDC, center positive (Please see details below). Green LED D9 (marked "Power") indicates when the power is connected.

Record LED (red) (D3, marked "**REC**" on the PCB)

This LED is on during recording.

Ready/Playback LED (green) (D2, marked "**IDLE**" on PCB)

This LED is OFF during playback. It is on when the system is ready to accept commands from the PC (the chip socket is powered down when this LED is steady green, so that it is safe to remove a chip in that condition)

When the user exits QV400D, the green LED is set to blink slowly, indicating a "sleeping" state.

Power Supply:

The programmer hardware requires an external power supply such as the one offered by Quadravox. Should you prefer to use another type, please ensure that it meets the following requirements.

Output Voltage: 9 VDC
Current: 200 mA minimum

Note: Quadravox provides a power supply with an AC input specification and power plug suitable for either North America (110 v AC, 60 Hz) or continental Europe (220 v AC, 50 Hz, round pin plug). Our overseas customers must ensure that the input voltage specification and power plug meet local requirements.

Socket Adapters:

All QV400D adapters have only one socket on the top side and two rows of 200 mil long .025" IDC headers (100 mil pitch) at the bottom. The rows of IDC pins are plugged into the appropriate ZIF socket.

The list below shows the adapter type and the appropriate ZIF socket on QV400D programmer board where it should be plugged in.

Adapter #	For device type	Package Type	Plug into QV400D socket marked
QV400D-01	ISD1500P	28/600 DIP	ISD1000-ISD2500
QV400D-02	ISD1600P	28/600 DIP	ISD1000-ISD2500
QV400D-03A	ISD5008P	28/600 DIP	ISD33000-ISD4000
QV400D-03B	ISD5008S	28/300 SOIC	ISD33000-ISD4000
QV400D-04	ISD1100S 1200S 1400S 2500S	28/300 SOIC	ISD1000-ISD2500
QV400D-05	ISD1000G, ISD2500G	28/350 SOIC	ISD1000-ISD2500
QV400D-06	ISD33000S & ISD4000S	28/300 SOIC	ISD33000-ISD4000
QV400D-07	ISD33000E & ISD4000E	28-pin TSOP	ISD33000-ISD4000
QV400D-08	ISD33000 & 4000 based module	---	ISD33000-ISD4000

Adapter QV400D-08 is for in-system programming of ISD33000 or ISD4000 based modules. The 10-pin (2x5) shrouded IDC header indicates the IDC Pin#1. The list below shows the cross-reference between IDC pin numbers and ISD33000-4000 pin numbers and functions:

IDC Pin #	Pin Function	ISD33000 Pin #
1	MOSI	2
2	SCLK	28
3	INT_	25
4	SS_	1
5	ANA-OUT	13

IDC Pin #	Pin Function	ISD33000 Pin #
6	N/C	--
7	VSSA / VSSD	11, 12, 23, 4
8	VCCA / VCCD	18, 27
9	ANA-IN-	16
10	ANA-IN+	17

Quadravox

Chapter 4. Quadravox Universal Speech Tools: QV400S

Overview:

QV400S™ is a software package designed to unify the interface between users and various speech development systems produced by Quadravox. It consists of one executable file, QV400S0.exe (for Windows 3.11) or QV400S1.exe (for Windows 95 or later), several DLLs (one at least for each development system), several help files, and an initialization file, QV400S0.ini. (Win3.11) or QV400S1.ini (Win95 or later);

Adding the capabilities for a new development system will only require the adjunction of a DLL to the existing software. The user interface, residing in the main executable file, will be unchanged.

This chapter (Chapter 4) only contains the general description of the user interface. Chapter 5 covers the description for the speech processing system specific to ISD programming.

Opening Window

When the QV400S program is first invoked, the opening screen comes up with four menus and a few icons on the icon bar. The 4 menus are:

Project Menu:

Open: open an existing project

New: open a new project

Exit: terminate and exit

Special DLL menu option: one special menu command per DLL is inserted here by the DLLs associated with the QV400S software. For example, for ISD, the special option is "import iQbox project" (Dialog box). This option is also available from the "Program" menu, once an ISD project has been opened.

Last 5 projects invoked: the list of the last five projects used is appended to this menu to provide a short cut to these projects.

Options Menu:

The only choice here is the DLLs menu, which allows the user to add/remove Quadravox supplied DLLs.









Window Menu:

the usual TILE/CASCADE menu

Help Menu:

This help file only contains the general description of the user interface. Help for the different speech processing systems is context sensitive, and can be accessed when the software is running.

Main Window Icons

-  : Open project from disk
-  : Save project to disk
-  : Stop current operation
-  : Search for string in current window (project or concatenations)
-  : Find next string in current window (project or concatenations)
-  : Play selected files, in Sys mode
-  : Play selected concatenation, in Sys mode
-  : Play all concatenations containing first selected file, in Sys mode
-  : Play concatenation with successive insertion of selected files, in Sys mode

General Organization

Windows:

The QV400S software uses a Multi Document interface with 3 different windows:

Project window: contains a list of all wav files associated with a project. It keeps track of the types of processing performed on the files. It displays information about the files (comments, sampling frequency, duration, and creation date)

Concatenation window: contains a list of the concatenations associated with the project. Concatenations are simply sequences of files (processed or not) that will be heard in a particular project.

Information window: displays general information about the current project, notably the total memory requirements.

Each window has its own menu. The menu is displayed when the window is activated. A window is activated by simply clicking the left mouse button over its area. It is safer to click the left button on the window title bar, because clicking it on the client area of the window may trigger a certain action.

Quadravox

Chapter 4: Section A. QV400S : Project Window

This window is where the user enters all files pertaining to a project. The user can perform various operations on this collection of files.

There are seven menus in this window. The menus are loaded when the window is activated.

Project Menu:

- Add Files** : Brings an open file dialog, where the user can select files to be inserted at the current insertion point (indicated by columns of a different color) in the project. **Warning: Do not use spaces in your wav file names, or the files may not be added to your project.**

- Save** : Saves the current project under the current project name

- Save as...** : Allows the user to save the current project under a different name. Note that the current project keeps the same name and stays open. After the user selects a new name to save the project under, a dialog will appear, giving the user the opportunity to do a string replacement on all file names in the project.
The system first computes the longest common path in all the wav files and proposes it as the string to be replaced. The user can accept it or change it, then type the replacement string (new path) in the second edit box, and click on the "replace" check box. When OK is clicked, if the "replace" check box is checked all occurrences of the "replace" string will be replaced with the "with" string in the new project file. This feature can be used to port a project from one computer to another computer, if the directories are different.

- Close** : Closes the project. If anything has changed, the user will be given a chance to save it.

- Select Entire Project** : Selects all files in project. (same as CTRL+A)

- Unselect All** : Unselects all files in project

- Record** : Brings up a **dialog** to record a new file (See **Chapter 4C: Wav File Editing**)

- Delete Files** : Removes the selected files from the project. The files do not stay in the project window, as opposed to the "remove" option

- Open Concatenation Window** : Opens Concatenation Window (See **Chapter 4B: Concatenation Window** for details). The concatenation window is automatically opened when a project is opened. However, the user can close it, so this menu option allows the user to reopen it.

- Refresh All Windows** : Forces repainting of all windows

Options Menu:

- Preferences** : Brings up a preference dialog where the user can select various things related to the appearance of the concatenation window.
- Expand** : Selects the expanded view for the concatenation window: each concatenation name is followed by the list of phrases contained in the concatenation. The currently selected view has a check mark next to it.
- Collapse** : Selects the collapsed view for the concatenation window: only the concatenation names are shown. The currently selected view has a check mark next to it.

Wav play menu:

- Selected Phrases in Project** : Plays all the wav files selected in the project window, in the order they appear in the project window.
- Selected Concatenation** : Plays all wav files corresponding to the currently selected concatenation.
- All concatenations containing selected phrase** : Plays all wav files in all concatenations containing the first file selected in the project window.
- Selected Concatenation with insertion** : Plays the wav files in the currently selected concatenation, and insert the selected wav files in the Project window in lieu of the "deleted" file in that concatenation. See **Play with insertion** below.

Sys Play Menu:

This is the same as wav play, except that the "system files", i.e. the processed files are played, instead of the wav files. For example, on an ISD system the files are played from the chip, on an ADPCM system, the coded files are played, etc.

- Selected Phrases in Project**
- Selected Concatenation**
- All concatenations containing selected phrase**
- Selected Concatenation with insertion**

Variable Menu:

This menu location varies with the speech processing system and is filled in by the DLL. See Help for the various processing systems. The menu is the same as the one in the concatenation window.

Window Menu:

- Cascade**
- Tile Horizontal**
- Tile Vertical**
- Arrange Icons**
- Close All**

Help Menu

File Manipulation:

To select a file, click the left mouse button on its name: it becomes highlighted in yellow. Selection of multiple individual files is accomplished by CTRL+Left clicking on the file. Selection of a group of consecutive files is accomplished by SHIFT+Left clicking on the last file of the group, after selecting the first one by LEFT+Click. Clicking the right mouse button in any column except the rightmost column and the processing column brings up the following menu:

- Select File** : selects the file at the mouse cursor location
- Unselect File** : unselects the file at the mouse cursor location
- Remove File** : removes the file at the mouse cursor location from the project (See insertion)
- Reinstate File** : puts a "removed" file back into the project
- File Info** : brings up the file info dialog, where the user can change the comments on a file, listen to it, etc.
- Insert Files** : brings an open file dialog, where the user can select files to be inserted at the current mouse location in the project. The allowed file formats and sampling frequencies depend on the system being used. For most Quadravox applications, the files should be Wav files, coded linearly on 16 bits, at a sampling frequency of 8000, 10000 or 11025 Hz.
- Edit File** : edit a wav file

Note that the project file accepts drag and drop files from the File Manager or Windows Explorer. Also, the user can move files in the Project Window by holding CTRL down while clicking the RIGHT mouse button to select the file to move: a special cursor appears:



where the arrow points to the "hot" location.

The user can then drag the selected file to the desired location in the project. The file is dropped immediately BEFORE the location of the mouse when the RIGHT mouse button is released. If the mouse is released in the blank space after the last file in a project, the dragged file is moved to the end of the project.

Clicking the right mouse button on the rightmost column brings up a menu that is specific to the current DLL.

Play with Insertion

This is a relatively complex operation that needs to be explained in some detail.

The purpose is to be able to hear a concatenation with a variable element. First, the variable element has to be inserted in a concatenation. The easiest way to do that is to have a “dummy” wav file that is not really part of the project, but that will be used only for that purpose:

- Insert the dummy file in the project
- Click the right button on it: a menu appears. Click on the “remove” option. The file is highlighted in gray, meaning that it is temporarily removed from the project. It can now be used as a place holder for insertion.
- Insert the dummy file in the concatenation

The user can now select a certain number of files (n) in the project window. If the user now chooses the “**Play concatenation with insertion**” menu option, the selected concatenation will be played n times, each time one of the selected files will be played in lieu of the “dummy” file inserted in the concatenation.

Information Window Menu:

The information window menu is the same as the **project window menu**

The information window contains information that is different according to the hardware that is currently being used. See the individual help files for a description of the contents of the information window.

Quadravox

Chapter 4: Section B. Concatenation Window

This window is where the user enters all concatenations pertaining to a project. The user can perform various operations on this collection of Concatenations.

There are seven menus in this window. The menus are loaded when the window is activated.

Concatenation Menu:

- Add Concatenation** : Insert a concatenation. A **dialog** will prompt the user for a name to give the new concatenation. The user can also choose to insert it before or after the currently selected concatenation. This dialog also has an option for “auto-numbering” of concatenations. If this option is checked, the user can enter a root name, and a starting number in the edit boxes next to it. As long as this option is checked, every time a concatenation is added using the “add concatenation” menu option, the name of the concatenation will be automatically generated as the root name followed by the number incremented by one.
- Delete Concatenation** : Delete the currently selected object, concatenation, or file in a concatenation. The object is not actually deleted, just removed from the concatenation window.
- Copy Concatenation** : Copies the currently selected concatenation to an internal clipboard. The copied concatenation can later be “pasted” to create a new concatenation with the same phrases. (can also be done with CTRL_C)
- Paste Concatenation** : creates a new concatenation with the copied concatenation (can also be done with CTRL_V)
- Insert First Highlighted Phrase** : Inserts the first highlighted phrase from the main window into the current concatenation.
- Insert Every Phrase** : Creates one concatenation for every phrase in the project. If several processing versions exist for a file, each of them is inserted in the concatenation. This is a quick way to make sure that all files in a project will be used, since the system only uses the files that appear in concatenations to perform the final formatting of a project.
- Insert All Phrases** : Creates one concatenation made up of all the phrases in the project. If several processing versions exist for a file, each of them is inserted in the concatenation. This is another quick way to make sure that all files in a project will be used, since the system only uses the files that appear in concatenations to perform the final formatting of a project.
- Change Name** : Brings up a dialog to change the name of the currently selected concatenation.
- Delete All Concatenations** : Allows the user to delete all concatenations in program, after confirmation. This option can be used to “clear” the concatenation window before building new concatenations from text, for example.
- Create Concatenations from Text** : Brings up a **dialog** that allows the user to build a list of concatenations from a text file. See “**Create Concatenation from Text**” below.

Options Menu:

- Preferences** : Brings up a preference dialog where the user can select various things related to the appearance of the concatenation window.
- Expand** : Selects the expanded view for the concatenation window: each concatenation name is followed by the list of phrases contained in the concatenation. The currently selected view has a check mark next to it. Note that double clicking on a concatenation name or on a file name in a concatenation toggles the expand/collapse status.
- Collapse** : Selects the collapsed view for the concatenation window: only the concatenation names are shown. The currently selected view has a check mark next to it. Note that double clicking on a concatenation name or on a file name in a concatenation toggles the expand/collapse status.

Wav Play Menu:

- Selected Phrases in Project** : Plays all the wav files selected in the project window, in the order they appear in the project window.
- Selected Concatenation** : Plays all wav files corresponding to the currently selected concatenation.
- All concatenations containing selected phrase** : Plays all wav files in all concatenations containing the first file selected in the project window.
- Selected Concatenation with insertion** : Plays the wav files in the currently selected concatenation, and insert the selected wav files in the Project window in lieu of the "deleted" file in that concatenation. **See play with insertion.**

Sys Play Menu:

This is the same a wav play, except that the "system files", i.e. the processed files are played, instead of the wav files. For example, on an ISD system the files are played from the chip, on an ADPCM system, the coded files are played, etc.

- Selected Phrases in Project**
Selected Concatenation
All concatenations containing selected phrase
Selected Concatenation with insertion

Variable Menu:

This menu location varies with the speech processing system and is filled in by the DLL. See Help for the various processing systems

Window Menu:

Cascade / Tile Horizontal / Tile Vertical / Arrange Icons / Close All

Help Menu:

Concatenation Manipulation:

To select a concatenation, click the left mouse button on its name: it becomes highlighted in yellow. To select a phrase in a concatenation, click the left mouse button on its name: it becomes highlighted in green. Selecting a concatenation or a phrase in a concatenation makes the selected object the current object. Insertion and deletion commands apply to the current object.

To add a phrase to the current concatenation, shift click the right mouse button on the "processing column" for the file in the Project window. If several versions are available for this particular phrase, a menu will pop up to give the user a choice of versions, otherwise the file will be added directly to the concatenation.

To play a concatenation, click the right mouse button on the concatenation name: this will play the concatenation in "system mode", i.e. on whatever speech development system is currently associated with the QV400S software. To play a phrase in a concatenation, click the right mouse button on the phrase name. Right clicking on the concatenation name in a concatenation where a phrase is selected will play the whole concatenation.

To toggle between the "collapsed" and the "expanded" views of concatenation, double click the left mouse button on a concatenation name, or on a phrase name.

Create Concatenations from Text

This option can be used to generate concatenations based on the labels associated with the wav files in a project. The user must create an **ASCII text file**, one phrase per line, which contains the text of the concatenations to be generated. Punctuation and letter case are ignored. The system will examine all possible ways of creating the text of the phrase, given the labels of the individual wav files.

Note that the system will remove what it thinks is punctuation before trying to match the different labels to the given text. The user can define the characters that will be ignored in a match by changing an entry in the qv400s1.ini (or qv400s0.ini in Win3.1x) file:

in the project section, under punct_str, the default value is:

```
punct_str=~!@`#$%^&*()-_+={|}[];:"'<>./
```

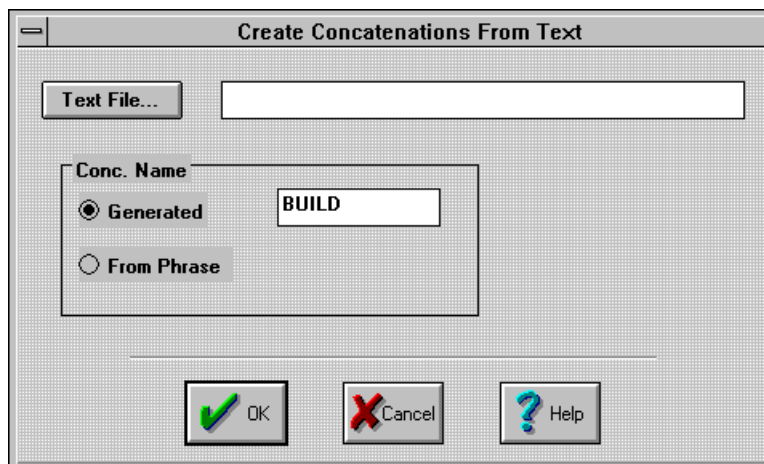

- Text File** : Click here to invoke a File Dialog to select the text file (default ext.: .phl) that contains the text used to generate concatenations. The file name can also be typed directly into the edit box.
- Conc. Name Generated** : If this radio button is checked, concatenation names will use the generic name in the edit box to name concatenations sequentially. The user can enter any other name (maximum16 letters) in the edit box. The default is "BUILD".
- Conc. Name From Phrase** : If this radio button is checked, the system will simply use the phrase text as the concatenation name
- OK** : Click here to generate the concatenations. An error message will be displayed if not all concatenations could be created. A result file (same name as phrase file, extension .res) is created. Errors are logged there.
- Cancel** : Click here to exit this dialog without creating concatenations.
- Help** : Click here to invoke the help file.

ASCII text file: Phrase File to Generate Concatenations from Text

This is an example of a .phl file to generate concatenations:

**The current time is 7ssm 30psm p.m.
The current temperature is 80psm 2f degrees Fahrenheit**

The labels on the .wav files (see **Sample Project for ISD**) are:

**[2f]
[30psm]
[5f]
[7ssm]
[80psm]
[the current time is]
[the current]
[temperature is]
[degrees]
[Fahrenheit]
[p.m.]**

The result file will be bidon.res, if the phrase file was bidon.phl. It shows the way the concatenations were formed, and the numbers of phrases that were rejected (could not be made out of the available wav files)

```

=====C:\NEWQV\BIDON.PHL=====
THE CURRENT TIME IS 7SSM 30PSM PM
  [the current time is] [7ssm] [30psm] [pm]
*****
THE CURRENT TEMPERATURE IS 80PSM 2F DEGREES FAHRENHEIT
  [the current] [temperature is] [80psm] [2f] [degrees] [Fahrenheit]
*****
0 phrases rejected

```

Meaning of suffixes in number wav files:

psm: primary stress medial
seq: sequence
f : final
ssm: secondary stress medial

example, 7 digit phone number

"my number is 123-4567"

digit 1 is psm
digit 2 is sequ
digit 3 is f
digit 4 is psm
digit 5 is f
digit 6 is ssm
digit 7 is f

Quadravox

Chapter 4: Section C. QV400S: Wav File Editing

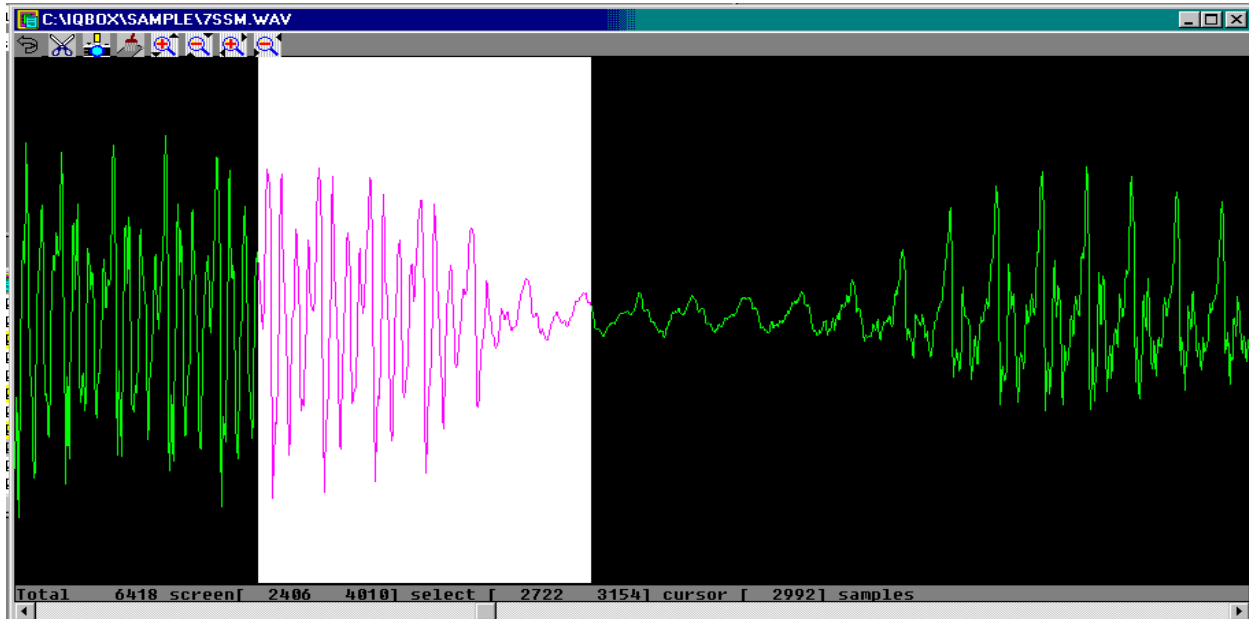

File Menu:

- Save** : Save changes in current file
- Save As** : Save changes under a different file name
- Save Selection** : Save selected region in a wav file, and add file to the project
- Exit** : Quit editor









Play Menu:

- Play Selected** : Play the selected region
- Play Whole** : Play the whole file
- Play Left** : Play the file before the beginning of the selected region
- Play Right** : Play the file after the end of the selected region

Window Menu:

The usual Windows rearranging menu

The Icon Bar

-  Undo last operation
-  Cut
-  Copy
-  Paste
-  Increase Vertical Scale
-  Decrease Vertical Scale
-  Zoom in
-  Zoom out

The Signal Window

Displays the sampled signal. The user can select a region by LEFT clicking and dragging. The selected region appears in inverted video. The copy, cut and paste commands apply to the selected region. Pasted starts at the beginning of the currently select region. RIGHT double clicking makes the selected region a one-frame region at the current cursor position.

The Information Line:

The line at the bottom of the window displays information about the current situation:

- | | | |
|---------------|---|---|
| Total | : | Refers to the whole file. The unit is samples, seconds, or milliseconds. The unit can be toggled by LEFT double clicking in this bottom window. |
| Screen | | Refers to what is displayed on the screen |
| Select | | Refers to the current selection (-1 for no selection); |
| Cursor | | Refers to the current location of the mouse cursor. |

Quadravox

Chapter 4: Section D. QV400S: Wav File Recording

This dialog is invoked from the Project/Record menu, once a project has been opened.

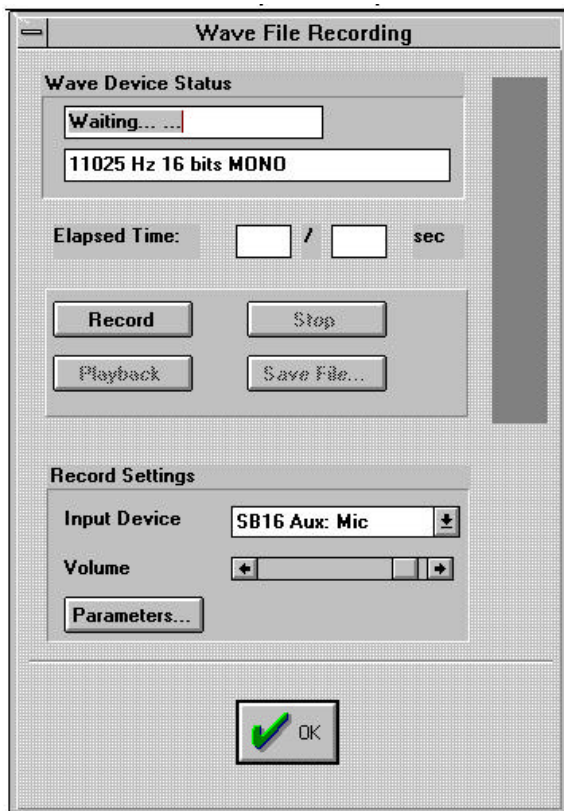

Wave Device Status :

The first line indicates the status of the input wav device (Waiting or recording), the second line indicates what type of wav file is being recorded (sampling frequency is one of 4 possible: 11.025, 10, 8 or 7.2 kHz, and 16 bits mono is the only option)

Elapsed Time:

The first number indicates how many seconds have already been recorded for the current file; the second number is the maximum number of seconds for a recorded file. This second number is a system parameter that can be changed by the user in the .ini file. The default value is 200 seconds. Available disk space is obviously the absolute limit for any recorded file.

Record:

Start recording. Recording will stop when STOP is pressed or the maximum duration is reached.

Stop:

Stop recording. Once a recording is stopped, it cannot be restarted. Before the next recording starts the user will be given a chance to save the previous recording.

Playback:

Start playback of recorded file (playback starts from the beginning)

Save File:

Save current recording into a wav file. This file will be added to the currently opened project.

Record Settings:

- Input Device** : The user can choose an input device among those available
- Volume** Set volume on currently selected input device. The gauge on the right hand side will monitor the input volume during recording. If overflow occurs, it will turn red and stay red to indicate the overflow occurrence. Otherwise it is black.
- Parameters** Choose sampling frequency; only the sampling frequencies allowed in the project are enabled.
- OK** Exits the recording dialog. If the last file was not saved, the user will be given the opportunity to save it.

Quadravox

Chapter 5. Universal Speech Tools: ISD Programming

Overview:

The `isd_dll.dll` file is a set of routines that allow for programming of various ISD chips, using hardware provided by Quadravox. These routines are used in conjunction with the user interface implemented in **QV400Sx.exe**

The following topics are covered below:

- Project Open Dialog
- Project Window Display
- Concatenation Window Display
- Information Window
- ISD chip reference
- The Program Menu
- Sample Project
- Table Preparation for Quadravox Gang Programmer QV40xP

First Time Run

When the user opens an ISD project for the first time after the installation of the QV400S software, the system will request the following information:

In the Open Project Dialog, the system will bring up a dialog to define the input and output channels that will be used for recording and playback. 2 list boxes will appear, containing the list of WAV IO devices present on the system. Pick the ones you will use for input and output.

The Project Open Dialog:

This dialog is invoked every time a new or existing project is opened. If the already existed, this is an opportunity for the user to modify certain parameters.

Only a few boxes are required to be filled in the opening dialog for a project:

ISD system selection:

Tells the system which Quadravox ISD hardware is going to be used.

ISD Chip selection

Tells the system which ISD chip will be used. (See **ISD CHIP Reference** section for more information)

If the **Multi Chip** box is checked, support for multi-chip projects is enabled (see below for more information).

Multi Chip Support:

If the user checked the multi-chip box in the project open dialog, support for multi-chip projects is enabled. What this means is that if a project becomes larger than the total duration of the chip it is associated with, the system will automatically allow for one or more similar chips to be programmed at recording time to contain the whole project. **The maximum number of chips for a multi-chip project is 4, numbered from 0 to 3.**

At recording time, phrases are recorded one after another, and the system pre-computes the space necessary for the file before it attempts to record it onto the ISD chip. If it is determined that there is not enough room, the system will pause and ask the user to plug in the next chip. The current chip number is automatically increased, and will appear in parentheses at the end of the address information in the project window.

Since there is no way for the system to know which chip (if any) is in the socket; the user is responsible for placing the correct chip in the socket during playback. Similarly, concatenations using phrases from different chips cannot be heard correctly. They should be tested in wav format only. When multi-chip support is enabled, the table creation program will create one table (extension: .tbx, with x=0,1,2,3) for each chip that is necessary to record the whole project.

Project Window Display

File Name	Label	Duration	Frequency /Date	Insertion Column
0001*: C:\IQBOX\SAMPLE\2F.WAU	2F	590 msec	Thu Oct 10 21:50	SHIFT+Right cliid 0x0007 --> 0x000C (0)
0002 : C:\IQBOX\SAMPLE\30PSM.WAU	30psm	422 msec	Thu Oct 10 21:51	SHIFT+Right cliid 0x000C --> 0x0010 (0)
0003*: C:\IQBOX\SAMPLE\5F.WAU	5f	541 msec	Thu Oct 10 21:51	SHIFT+Right cliid 0xFFFF --> 0xFFFF (0)
0004 : C:\IQBOX\SAMPLE\7SSH.WAU	7ssm	582 msec	Thu Oct 10 21:51	SHIFT+Right cliid 0x0010 --> 0x0015 (0)
0005*: C:\IQBOX\SAMPLE\80PSM.WAU	80psm	466 msec	Thu Oct 10 21:51	SHIFT+Right cliid 0x0015 --> 0x0019 (0)
0006*: C:\IQBOX\SAMPLE\FILE0019.WAU	the current time	1530 msec	Wed Oct 23 21:24	SHIFT+Right cliid 0x0019 --> 0x0024 (0)
0007*: C:\IQBOX\SAMPLE\FILE0020.WAU	the current	624 msec	Tue Oct 01 21:19	SHIFT+Right cliid 0x0024 --> 0x0029 (0)
0008*: C:\IQBOX\SAMPLE\FILE0097.WAU	pn	750 msec	Tue Feb 16 15:21	SHIFT+Right cliid 0x0029 --> 0x002F (0)
0009*: C:\IQBOX\SAMPLE\FILE0102.WAU	temperature is	1252 msec	Thu Oct 10 21:52	SHIFT+Right cliid 0x002F --> 0x0038 (0)
0010*: C:\IQBOX\SAMPLE\FILE0103.WAU	degrees	709 msec	Thu Oct 10 21:52	SHIFT+Right cliid 0x0038 --> 0x003D (0)
0011*: C:\IQBOX\SAMPLE\FILE0106.WAU	Fahrenheit	667 msec	Tue Mar 16 09:45	SHIFT+Right cliid 0x003D --> 0x0042 (0)

- Project Name** The title bar contains the name of the currently opened project.
- Current Chip** The title bar contains the name of the current ISD chip for this project.
- Asterisk** An asterisk (*) in the first column means that this file is used in at least one concatenation, so that it will be programmed on the chip at programming time.
- File Selected** A file on a yellow background is “selected”. To select a file, LEFT+click on the file name (or use the right button menu on any column except for the “processing” column) and choose the select option. Certain operations like deletions, or playback are performed on all selected files. To unselect a file, LEFT+click on another file, or use the right button menu and choose unselect.
- File Removed** A file on a gray background is “removed”. Removed files are no longer part of the project. They can be used in a **concatenation with insertion** (see Chapter 4, Section B) command. They can be reinstated by using the right mouse button (option: Reinstated File)
- Label** The file label is displayed in the second column. It can be changed by using the right button menu, option File Info.
- Duration** The file duration, in milliseconds, is displayed in the third column.
- Frequency /Date** The file sampling frequency, or creation date, is displayed in the fourth column. What is displayed here is determined in the Preference Dialog (Options menu)
- Insertion Column** The fifth column has a special purpose. For an ISD project, it will always display “SHIFT + Right click to insert”: SHIFT+Right click on a file name in this column (and in this column only) will automatically add that file to the currently selected concatenation, after the currently selected file in the concatenation. Another way to insert a file in a concatenation is first to select it, then to use the Concat / Insert First Highlighted File menu item.

Project Window Display (continued)**Addresses**

The starting address (hexadecimal or decimal) and the starting address of the next word are displayed in the rightmost column. A value of 0xFFFF (hexadecimal mode) or 65535 (decimal mode) is displayed if the file has not been programmed yet. If the address is displayed on a RED background, this address is a fixed address; i.e. the system will always program this file at that address. To fix an address, click the right button over the address column and choose the fixed address option. The free address option will "free" the address; i.e. the file will be programmed at the end of the previous file at programming time.

This column also has a special importance. RIGHT clicking on this column will cause a menu to pop up, with the following options:

- Free Address: free the address of the file at cursor location
- Fix Address: brings up dialog to fix address of file at cursor location
- Free All Addresses: free all file addresses
- Fix All Addresses: fix all file addresses at their current values, if not -1
- Toggle Hexadecimal/Decimal display

Concatenation Window Display

To play a concatenation, click the right mouse button on the concatenation name: this will play the concatenation in “system mode”, i.e. from the ISD chip. To play a phrase in a concatenation, click the right mouse button on the phrase name. Right clicking on a concatenation name in a concatenation where a phrase is selected will play the whole concatenation.

Concatenations : []			
conc0009	temperature is 1 elements	00001252 msec	ISD
	degrees	00000709 msec	ISD
conc0010	1 elements	00000689 msec	
	Fahrenheit	00000689 msec	ISD
conc0011	4 elements	00002361 msec	
	30psm	00000422 msec	ISD
	5f	00000541 msec	ISD
	degrees	00000709 msec	ISD
	Fahrenheit	00000689 msec	ISD

Concatenation Name : The first column contains the name given to the concatenation. this name can be edited by using the Concat / change name menu option

Concatenation Elements : The second column contains the number of elements (phrases) in a concatenation, on the same line as the concatenation name. If the display is in expanded mode (Concat / expand), this column also contains the label of each element. In collapsed mode (Concat / collapse), only the concatenation names are listed, one per line.

Concatenation Element Label : The second column also contains the label given to a concatenation element (phrase) in the project window. It only appears if the display is in expanded mode.

Concatenation Selected : The currently selected concatenation is highlighted in yellow. Only one concatenation can be selected at a time. To select a concatenation, click the left mouse button on the concatenation name.

Phrase Selected in Concatenation : The currently selected phrase (if any) in the currently selected concatenation is highlighted in green. Only one phrase at a time can be selected in a concatenation. To select a phrase, click the left mouse button on the phrase name. To unselect a phrase, click the left mouse button on the concatenation name or on another phrase name. Selecting a phrase in a concatenation automatically selects the concatenation.

If a phrase is selected in a concatenation, the play operations on that concatenation will only play that phrase.

Duration of Concatenation and Elements : The third column contains the total duration of the concatenation, on the same line as the concatenation name (and its number of elements). In expanded mode, this column also contains the duration of the various elements of the concatenation, on the same line as their label.

Information Window Display

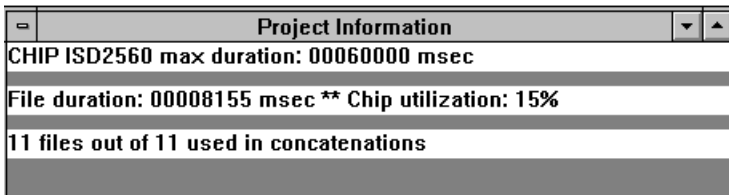

Project Information	
CHIP	ISD2560 max duration: 00060000 msec
File duration:	00008155 msec ** Chip utilization: 15%
11 files out of 11 used in concatenations	

Chip Type and Duration:

The first line in the information window lists the chip type and its duration, in milliseconds.

Project Duration and Chip Utilization:

The second line lists the project duration (i.e. the sum of the durations of all wav files involved in the project), and the memory occupation, in percent. Note that due to the granularity of the ISD chips and other factors, the duration represented by this percentage is ALWAYS larger than the sum of the file durations.

Number of files in the project used in concatenation:

The third line states how many files in the Project Window are actually used in concatenations. **Those files are the only ones that will be programmed on the ISD chip in automatic mode.**

ISD chip reference

The following table describes the ISD chips supported by Quadravox hardware.

Chip Name	Sampling Freq (kHz)	Duration (msec)	Granularity (msec)	Adapter required
ISD1016	8.0	16000	100.0	
ISD1020	6.4	20000	125.0	
ISD1110	6.4	10000	125.0	
ISD1112	5.3	12000	150.0	
ISD1210	6.4	10000	125.0	
ISD1212	5.3	12000	150.0	
ISD1416	8.0	16000	100.0	
ISD1420	6.4	20000	125.0	
ISD1510	6.4	10000	N.A	QV400D-01
ISD1606-4.8	8.0	4800	N.A	QV400D-02
ISD1606-6.0	6.4	6000	N.A	QV400D-02
ISD1606-7.2	5.3	7200	N.A	QV400D-02
ISD1606-9.6	4.0	9600	N.A	QV400D-02
ISD2532	8.0	32000	100.0	
ISD2540	6.4	40000	125.0	
ISD2548	5.3	48000	150.0	
ISD2564	4.0	64000	200.0	
ISD2560	8.0	60000	100.0	
ISD2575	6.4	75000	125.0	
ISD2590	5.3	90000	150.0	
ISD25120	4.0	120000	200.0	
ISD33060	8.0	60000	150.0	
ISD33075	6.4	75000	187.5	
ISD33090	5.3	90000	225.0	
ISD33120-4	4.0	120000	300.0	
ISD33120	8.0	120000	150.0	
ISD33150	6.4	150000	187.5	
ISD33180	5.3	180000	225.0	
ISD33240	4.0	240000	300.0	
ISD4002-120	8.0	120000	200.0	
ISD4002-150	6.4	150000	250.0	
ISD4002-180	5.3	180000	300.0	
ISD4002-240	4.0	240000	400.0	
ISD4003-04	8.0	240000	200.0	
ISD4003-05	6.4	300000	250.0	
ISD4003-06	5.3	360000	300.0	
ISD4003-08	4.0	480000	400.0	
ISD4004-08	8.0	480000	200.0	
ISD4004-10	6.4	600000	250.0	
ISD4004-12	5.3	720000	300.0	
ISD4004-16	4.0	960000	400.0	
ISD5008-04	8.0	240000	200.0	QV400D-03A
ISD5008-05	6.4	300000	250.0	QV400D-03A
ISD5008-06	5.3	360000	300.0	QV400D-03A
ISD5008-08	4.0	480000	400.0	QV400D-03A

Quadravox ISD1500 Adapter

A special adapter is required to program ISD1500 series chips on the QV400S / QV400D system. This adapter must be plugged in the ZIF socket marked "ISD1000-ISD2500" on the QV400D board. The 15xx chip can then be plugged in the adapter. The user should use the manual programming dialog to program ISD15xx chips, since only one message can be recorded on those chips. For this reason, the address for playback and recording in this dialog is ignored for ISD15xx chips.

The oscillator resistor is socketed to allow variation of the sample rate and hence playback length.

Quadravox ISD1600 Adapter

A special adapter is required to program ISD1600 series chips on the QV400S / QV400D system. This adapter must be plugged in the socket marked "ISD1000-ISD2500" on the QV400D board. The 16xx chip can then be plugged in the adapter. The user should use the manual programming dialog to program ISD16xx chips. One or two messages can be recorded on a 16xx chip, depending on the position of a jumper on the adapter board. The user must use the manual recording dialog to take advantage of this feature:

If the jumper is in the 1-message position (shorting), the record and playback addresses are ignored in this dialog.

If the jumper is in the 2-message position (open), address 0 will be used for the first message, and any address other than zero will be used for the second message.

The oscillator resistor is socketed to allow variation of the sample rate and hence playback length.

Quadravox ISD5008 Adapter

A special adapter is required to program ISD5008 series chips on the QV400S / iQbox system. This adapter must be plugged in the socket marked "ISD33XXX" on the QV400D board. The 5008-xx chip can then be plugged in the adapter. The user can use the normal programming functions of QV400S once this adapter is in place.

The Program Menu

The Program menu is attached to the Project window by the DLL. This is the menu that is used for programming ISD ChipCorder devices and to modify hardware parameters.

- Manual** : Brings up a **dialog** that allows the user to select any file in the project, and to program it at any valid address on the ISD chip. This dialog also allows the user to play from any valid address on the ISD chip.
- Automatic** : Brings up a **dialog** that will initiate the programming of the project on the ISD chip. A check box allows the user to decide if the programming function should start automatically when this menu option is invoked, or wait for the user to click the start button. Files are programmed in the following order:
- Files at fixed addresses, in increasing order of fixed addresses
 - All other files, taken in the order they appear in the project window, provided that they are used in at least one concatenation.
- Fix all addresses: all addresses are fixed at the value they currently have (except for FFFF)
Free all addresses: all addresses are free
- Setup** : Brings up a **dialog** that allows the user to change some parameters related to the recording function. These **parameters** depend on the ISD system being used.
- Reset** : Resets whatever ISD hardware is currently connected.
- Create Table** : Brings up a **dialog** (see next page) that allows the user to create different tables related to the project. The system will create a file containing the addresses of files on the chip. It also creates a table that can be used in a C program to define concatenations. The user can choose to create the table from the information in the project itself (if the project has already been recorded on chip), or from the wav files. The latter method is a fast way to create the table without having to go through the recording process.
- Import iQbox Project** : Allows the user to import an old iQbox project into the new QV400S format. The user must first open any ISD project to make the Program menu available. After the old iQbox project (extension .ipf) is imported, the user must first close the current project, then open the imported project to have access to it.

Alternatively, the user can invoke the "Import iQbox Project" menu option from the main window's "Project" menu.

Note that concatenations containing more than 32 elements will be split into smaller chunks to be compatible with the QV400S software.

Create Table Dialog

This dialog allows the user to create 2 (or more, see **Multi chip support**) tables related to the project, one with extension **.tbl** that contains the addresses of the phrases on the ISD chip and the information for concatenations, one with extension **.qnz** that defines the concatenations in C language.

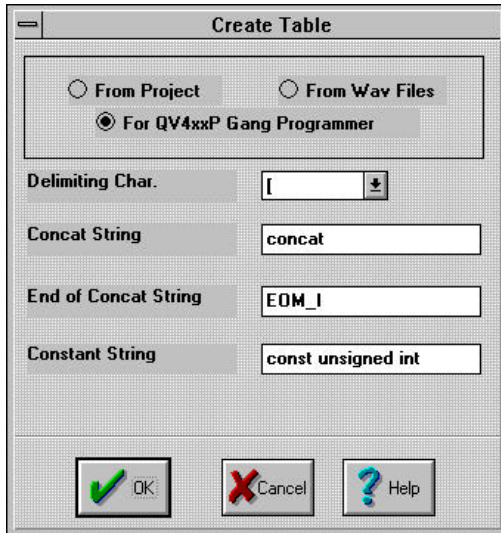

From Project:

Addresses already computed are used to create table

From Wav Files:

The system computes the addresses before creating the table (without actually recording the files to the ISD chip).

For QV4xxP Gang Programmers:

As for "From Wav Files" except that the two "fudge" coefficients **epsilon1** and **epsilon2** (of iQbox fame) are set to zero.

- Delimiting Char.** : If "[" (bracket) is chosen, the table created is suitable for use in an assembly language program. If ",", (comma) is chosen, the table created can be imported into a spread sheet program (option: comma delimiter) for further processing.
- Concat String** : This string is used to name concatenations in the C table
- End of Concat String** : This string is used in the C table to mark the end of a concatenation
- Constant String** : This string is used in the C table to type cast the variables.
- Advanced C Format** : If this box is checked, the ".qnz" file will be created with #define statements for the addresses of phrases. Concatenations will be listed in terms of the defined labels. Conditional assembly statements based on the definition of "QV_ISD_SPEECH" allow for this file to be included in several C source files. The file where QV_ISD_SPEECH is defined will contain the actual definition of the arrays; the other files will reference this array as external. If the box is not checked, the concatenations in the .qnz file are listed in terms of the actual addresses of phrases.
- OK** : OK to create the tables
- Cancel** : Cancel to quit
- Help** : Help to invoke this file

```
;  
;  
; Concatenation Table  
;  
CONC0000  
;[the current time ...]  
;  
; DATA 0011 ;[the current time is]  
;  
; DATA 000A ;[7ssm]  
;  
; DATA 0004 ;[30psm]  
;  
; DATA 0007 ;[5f]  
;  
; DATA 001D ;[p.m.]  
;  
CONC0001  
;[The current temperature ...]  
;  
; DATA 0019 ;[the current]  
;  
; DATA 0021 ;[temperature is]  
;  
; DATA 000E ;[80psm]  
;  
; DATA 0000 ;[2f]  
;  
; DATA 0028 ;[degrees]  
;  
; DATA 002C ;[Fahrenheit]  
;  
;
```

Example of C table

```
const unsigned int concat_1[6]={
    0x0011,      //[the current time is]
    0x000A,      //[7ssm]
    0x0004,      //[30psm]
    0x0007,      //[5f]
    0x001D,      //[p.m.]
    EOM_I
};
//*****
const unsigned int concat_2[7]={
    0x0019,      //[the current]
    0x0021,      //[temperature is]
    0x000E,      //[80psm]
    0x0000,      //[2f]
    0x0028,      //[degrees]
    0x002C,      //[Fahrenheit]
    EOM_I
};
//*****
```

Table Preparation for Quadravox Gang Programmer QV40xP

The QV400S software can be used to prepare data for the Quadravox Gang Programmers **QV401P** and **QV402P**. No hardware is needed for this purpose. Once the user has defined the project to be recorded using the QV40xP products, the **project table** (see create table dialog) must be created using the third radio button option: "**For QV4xxP Gang programmer**". This option automatically sets the "**epsilon factors**" (see below) to zero, which is what is required for optimal addressing.

The table can then be used as input to the gang programmer program.

Parameters Dialog

This dialog appears when the “Parameters” button is pressed in the **SetUp dialog**.

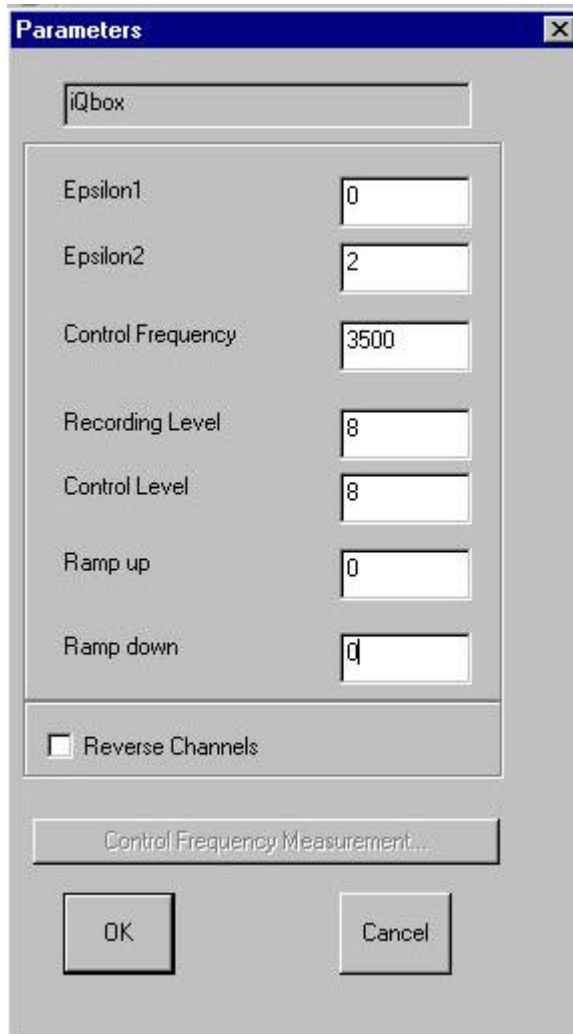

System Name :

For now, one system only is available: iQbox.

Epsilon1 and Epsilon2 :

The Quadravox QV400D product does not drive the clock of the ISD chips. Consequently, it has to deal with the range of sampling frequencies defined in the ISD spec to compute starting addresses that eliminate the risk of overlap between utterances. Epsilon1 is the uncertainty factor (in percent) on the sound card sampling frequency. It can usually be safely set to 0. Epsilon2 is the uncertainty factor (in percent) on the ISD chip sampling frequency. A safe value seems to be 2.

These factors are used in the computation of addresses whenever a project is recorded to an ISD chip using the QV400D hardware. The QV4xxP gang programmers from Quadravox do not need these epsilon factors, since they drive the ISD chip clock. Consequently, the table creation program will temporarily set these two coefficients to 0 when computing a table address for QV4xxP.

- Control Frequency** : This is the “carrier frequency” used to communicate with the QV400D on the “control channel” of the stereo cable. From board ISDPRG04 onwards, this number is fixed at 3500 or 4500Hz. The dialog reference is retained for use with earlier PCBs.
- Recording Level** : The user can vary the recording level from 0 (mute) to 15. If this level is too low, the quality of the ISD recordings will be noisy. If it is too high, the recordings will be saturated.

Parameter Dialog (continued)

- Control Level** : The user can vary the control level from 1 to 15. If the control level is too low, the board will not recognize the commands from the computer. If it is too high, the commands MAY be distorted and poorly recognized also.
- Ramp Up** : This parameter should be set to 0.
- Ramp Down** : This parameter should be set to 0.
- Switch Channels** : Some sound cards have their channels "reversed"; i.e. what is generally the left channel may be the right channel on a certain sound card. If your QV400D does not seem to respond to any commands, try to check this option and see if the QV400D behaves normally.

Changing the ISD chip in a project

There are two ways to change the ISD chip defined in a project:

- When opening a project, a dialog appears that allows the user to change some of the project's parameters (name of project, name of customer, whether the project is a multi-chip project, etc.). One of the parameters that can be changed then is the ISD chip.
- Once a project is opened, go to the Program menu in the main window or the concatenation window, and choose the Setup option. A dialog appears where the user can change the name of the chip for the project.

The user should of course replace the chip in the QV400D socket with the newly designated chip. Remember that it is safest to change the chip when the green LED is on, indicating that the system is idle/powered down.

Quadravox

Chapter 6. Sample Project for QV400S.exe and ISD chips

Overview:

What follows is a quick tutorial on how to use Quadravox's **QV400S.exe** software package to program ISD™ chips, i.e. record sounds onto those chips.

During installation of the package, you will be (or have been) prompted for a directory name where most of the files will be created. The default name is c:\dQbox. This is the name we will use during this tutorial. If all goes well, the installation program will place (or has placed) the **QV400S** icon in a program group called "Quadravox".

The eleven wav files that constitute the project have already been copied in the "sample" subdirectory of your **QV400S** directory.

To invoke **QV400S**, click on the icon, or run **qv400s.exe** from the File Manager or Windows Explorer.

Throughout this Sample Project, commands will be described as follows:

- [A]** : type the letter A
- /Menu1/Menu2/** : choose menu Menu1, then menu or menu option Menu2
- *KeyName*** : press the dialog key marked: KeyName

(The brackets, slashes and stars are not typed, they are just here to indicate what type of action is required)

Opening Screen:

The opening screen looks like:

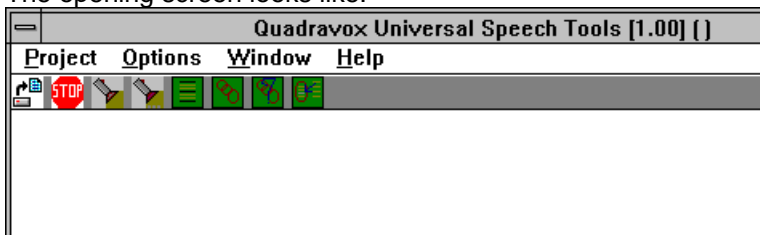

Note that only 4 menus are enabled: **Project... Options, Window and Help...**

You could invoke Help, but remember, this is a tutorial, so you should not need it.

We offer you a choice:

- if you are really in a hurry, you may go straight to **Fast Track Sample Project Tutorial**
- Otherwise, we will go at a slower pace:

The first thing to do is to **Open a New Project**

Open New Project

In the notation described above, select menu **Project...**, then option **New...** .

/Project.../New../

A dialog called "Project Type Selection" appears. Choose ISD Project and click ***OK***.

A File Open dialog appears. The default extension for ISD **QV400S** projects is .QSD. Since this is a new project, you have to type, for example, **sample.qsd**

The project file can reside anywhere, since it will carry the full path to each of its files, but it is generally a good idea to keep it in the directory where the files reside, in our case **c:\dQbox\sample**.
(Note that the files don't have to all be in the same directory, but they will be for this tutorial)

Another dialog appears. Only 2 fields are important: ISD System Selection and ISD Chip Selection. Use the scroll down to select the ISD hardware you are working with. Also, select the ISD chip you will be programming. Don't worry, you can always **change** your mind later. When done, click ***OK***. The project window appears, and it is empty. Two other windows are created at this time, the concatenation window, and the project information window.

Now, we must **Add Files** to the project.

Adding Files to a Project

To add files to a project:

/Project.../Add Files.../

A File Open dialog appears. You can select several files at a time. Here, select all 11 files in the c:\dqbox\sample directory. Press ***OK***.

The screen should look like (if you chose ISD2560)

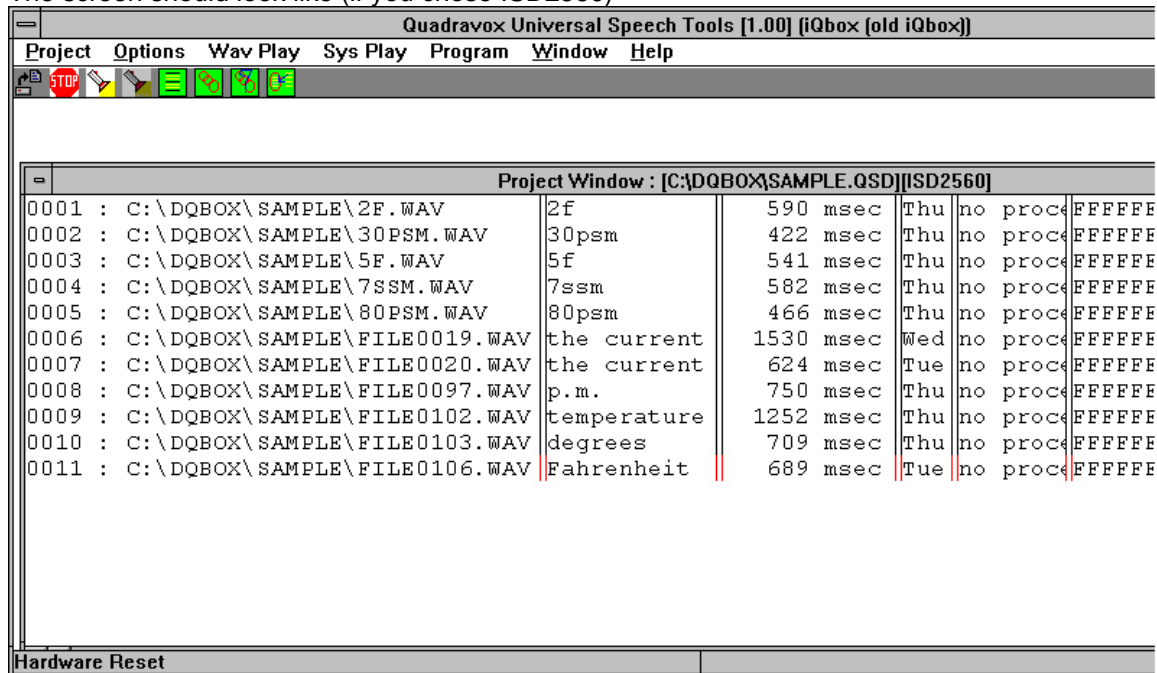

(Note that you can drag and drop files from File Manage or Windows Explorer to Project window.)

Note the six columns on the screen.

- First column** : File rank and File name, rank is followed by "*" if the file is used in a **concatenation**
- Second column** : File label, generally describing the utterance
- Third column** : File duration, in milliseconds
- Fourth column** : File creation date, or file sampling frequency depending on preferences
- Fifth column** : Type of processing performed on the file. For an ISD system only, the words "SHIFT+Right click" always appear in this column.
- Sixth column** : Start and end addresses of the file **recording on the ISD™ chip** (note that the end address is not included, and is the start address of the next phrase). A value of FFFF indicates that the file has not been programmed to a chip yet.

It is now time to **create concatenations**.

Inserting Concatenations

A **concatenation** is a sequence of phrases that are supposed to be pronounced one after the other. The recording time on a chip is limited. Consequently, to maximize memory utilization, it is advisable to create utterances from smaller chunks or phrases that can be used several times. Each individual phrase will be recorded once on the chip, but may be used in different contexts, attached to different phrases in our so-called concatenations. In our sample, we want to create two utterances:

The current time is 7:35 p.m.
The current temperature is 82 degrees Fahrenheit.

Note that there is no reuse of phrases in this simple example, but we can add concatenations like:

The current time is 7:32 p.m.
 or
The current temperatures is seven degrees Fahrenheit.

Click on the title bar of the concatenation window. This gives it the focus, and also changes the menu of the main window to the concatenation menu.

First, let's put the concatenation window in "expand" mode, so that we will see the file names being inserted:

/Concat../Options/Expand/

Now, let's create a new concatenation:

/Concat../Add/

The "Insert Concatenation" dialog appears:

Type for example **[CONC1]** for the name of the concatenation, then ***OK*** (remember: don't type the brackets or stars)

The concatenation screen is then:

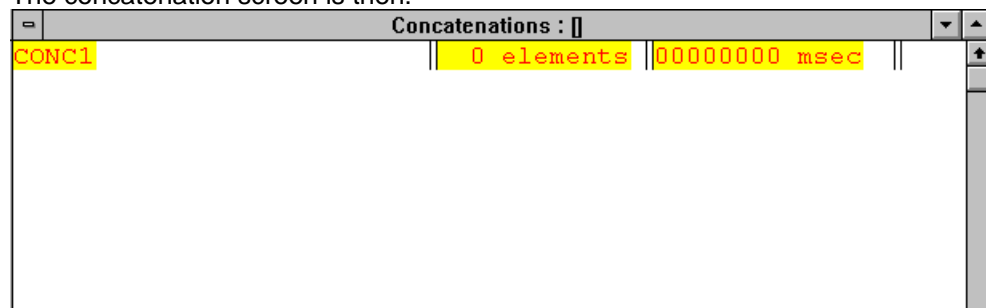

Now, we will **insert phrases**.

Inserting Phrases

Now that we created CONC1, we have to give it some content, i.e. a sequence of phrases that will make up our utterance. For CONC1, we want ***'the current time is 7 35 p.m.'***

We have to select the elements in order:

Make sure that you can see both the QV400D Main window and the concatenation window on your screen.

In the concatenation window, the "CONC1" line is highlighted in yellow, i.e. it is the currently selected concatenation, where insertions will be directed

Step 1

In the main window, shift+click the right mouse button over the ***"the current time"*** phrase (should be phrase 6), **in the processing column (fifth column)**. Shift clicking the right mouse button over any other column will bring up a short menu that we won't deal with in this tutorial. It is automatically inserted in the concatenation, and highlighted in green, making it the currently selected phrase in the concatenation.

The concatenation window looks like:

Concatenations : []			
CONC1	1 elements	00001530 msec	
	the current t	00001530 msec	ISD

Repeat step 1 for phrases number: 4,2,3 and 8 in that order: (note that the file numbering comes from the order in which the files were entered. We suppose here that the files were listed in alphabetical order in the directory. If not, let the file labels guide you)

Concatenations : []			
CONC1	5 elements	00003825 msec	
	the current t	00001530 msec	ISD
	7ssm	00000582 msec	ISD
	30psm	00000422 msec	ISD
	5f	00000541 msec	ISD
	p.m.	00000750 msec	ISD

Inserting Phrases (continued):**Step 2**

Now, create concatenation number 2 (call it CONC2, for example)

```
/Concat../Add/
[CONC2]
*OK*
```

and then insert phrases: 7,9,5,1,10,11, in that order

Concatenations : []			
CONC1	5 elements	00003825 msec	
	the current t	00001530 msec	ISD
	7ssm	00000582 msec	ISD
	30psm	00000422 msec	ISD
	5f	00000541 msec	ISD
	p.m.	00000750 msec	ISD
CONC2	6 elements	00004330 msec	
	the current	00000624 msec	ISD
	temperature i	00001252 msec	ISD
	80psm	00000466 msec	ISD
	2f	00000590 msec	ISD
	degrees	00000709 msec	ISD
	Fahrenheit	00000689 msec	ISD

By the way, it's a good idea to save your project, at this stage: Click on the title bar of the project window to give it the focus and change the menu to the project menu.

```
/project../Save/
```

Now we can **play our concatenations**

Playing Concatenations:

Before listening, we can look at the total size of our recording project:

The information window contains the total duration of 8,155 milliseconds, or just over 8 seconds. Note that this is the duration of the wav files. The actual duration of the recordings on the chip will depart slightly from this number, for various reasons. The system makes sure that the recording space is optimally used.

Before programming our concatenations, we may want to listen to them.

To listen to a concatenation, click on the concatenation name in the concatenation window. This makes it the current concatenation.

/Wav Play/Selected Concatenation/ will play the wav files corresponding to the concatenation.

To listen to a phrase or a sequence of phrases: select the phrases in the project window by CTRL+clicking on their names. They become highlighted in yellow.

/Wav Play/Selected Phrase(s) in project/ will play the sequence of wav files just selected.

There are many more features that can be used to edit and modify the phrases, but this is not the object of this tutorial.

The last step is now to **program the necessary phrases** (those marked in the main window with "**") on an ISD™ chip.

ISD™ Recording

/Program/Automatic.../

The following dialog appears

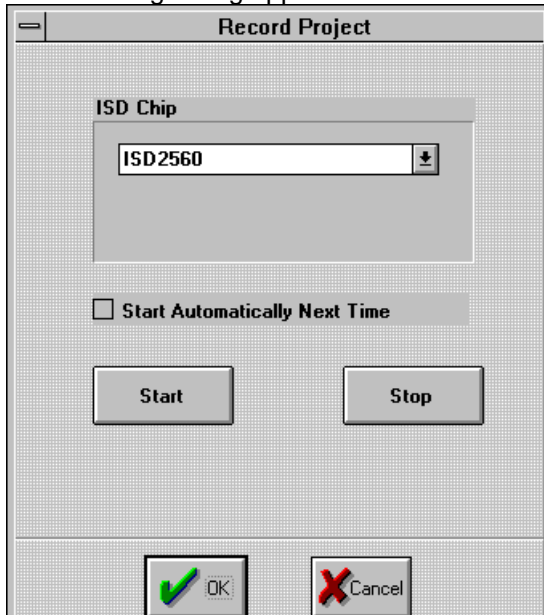

Select the chip you want by clicking on its name in the drop down list box, and place one of those chips in the recording socket. Since the total duration is less than 10 seconds, any of the supported chips can be used.

then click ***START***,

This will take slightly longer than the total duration of your project. If all goes well, the system will come back with the message:

11 Files sent to chip, at the bottom of the project window

Note that the addresses have now changed in the last column of the main window. These numbers are now the physical addresses of the phrases on the ISD™ chip. (There may be some further formatting of the address for certain chips, but this is transparent to the user).

To verify the recording, we **playback from chip**

Playback from Chip:

After we programmed our phrases on the chip, it is now time to listen to them. Go to the main window and select the phrases you want to listen to. (Selection is by clicking the left button over the file name (not on the vertical lines!). The file is then highlighted in yellow. The playback from the chip is based on the file addresses.

/Sys Play.../Selected File(s) in Project/

will play all selected files that have been recorded on the chip.

If you choose:

/Wav Play.../ Selected File(s) in Project /

all selected files will be played on the computer sound card.

This concludes this tutorial.

Fast Track Sample Project Tutorial

Since you are in a hurry, you will use the sample project file supplied with this software package, **sample01.qsd**.

Run **QV400S** from its icon or from the File Manager

In the main window:

/Project.../ Open... /

(click on the name of the project as it appears in the File Open dialog)

Then, click ***OK*** when the project information dialog appears.

The screen should look like:

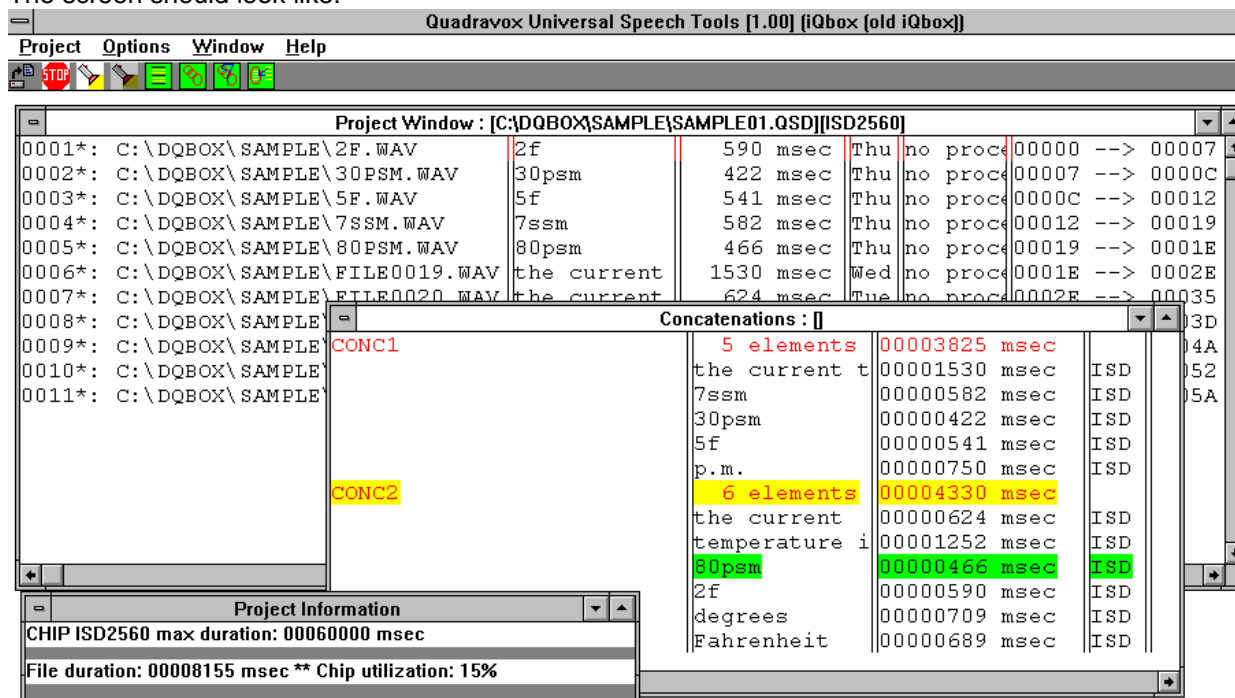

The predefined chip is ISD33120. If you have such a chip, place it in the programming socket. **Jump to the Programming the Chip line below.**

Otherwise, place one of the ISD chips supported by this software package in the programming socket, **and don't forget to change the chip name at recording time!**

Programming the Chip

We are now ready to program the chip. Make sure one more time that the power supply is connected and that there is a valid ISD chip in the correct socket:

Only one of the two sockets can be occupied at a time. ISD100 - ISD2500 chips go into the socket marked "ISD1000-ISD2500", ISD 33000, 4002-XX, 4003-XX and 4004-XX go in the socket marked "ISD33XXX-ISD4000".

Make sure that the Project Window has the focus (click on its title bar if not), so that the Project menu is available. The green LED should be on, indicating that the system is ready to accept commands.

If the green LED marked "IDLE" is not on,

/Program/RESET/

The green LED should now be on, and the red LED should be off. **If the green LED is not on, your system is not operational.**

If the green LED is on:

/Program/Automatic/

Change the chip type in the combo box if it is not correct. Then, ***START***. The 11 files contained in the project will be programmed on the chip. Each file is highlighted in the main window as it is being recorded. During the actual recording, the red LED comes on, and the green LED is off. The green LED will blink in between recordings. It should stay on when the recording is over.

To listen to the files you just recorded:

Be sure that you have a speaker connected to the speaker output of the box (8 Ohm speaker), or that your PC sound card speakers are connected to the MM (MultiMedia) speaker output of your QV400D

In the main window, select all 11 files by clicking the left mouse button on the first file, then clicking the left mouse button while holding the SHIFT key down on the last file. All 11 files should now be highlighted in yellow.

/Sys Play.../ Selected File(s) in Project /

The 11 files will be played one after the other, with a slight interval in between. They are highlighted on the screen as they are being played.

Exit the program:

/Project.../Close//Project.../Exit/

Quadravox

Chapter 7. Vocabulary Library

Overview:

In some cases it is possible to reduce data storage requirements by concatenating repetitively used words and phrases to make longer messages. While it's possible to record a separate "The time is ..." for each of the 1440 minutes in a day, it isn't very practical; you'd need about a hundred ISD2560 devices to do so. With concatenation, 24 seconds of data is enough.

Unfortunately, the saving comes at a price; without very careful recording, auditing, and editing of the pieces in context, the naturalness of the complete sentence is distorted. One way to solve this problem is to have a very carefully recorded and prepared vocabulary to build your phrases from. To facilitate this process, Quadravox has professionally recorded a standard vocabulary comprising 331 words to cover wide variety of applications.

The list below is for the purpose of making it convenient for you to see the words available for any specific application. However, in case you have a different application in mind or you want to check if a specific word is available in Quadravox library or not, please refer to the "**List of Words in Alphabetic Order**".

Users of QV400D may download the .zip files containing these words (in .wav format), free of charge, from the "Support" section of the Quadravox web site "www.quadravox.com". To ensure that the sizes of the .zip files are not excessively large, six different files are created according to the list below:

- **Alphabets (English & Military)** - alphabet.zip (approx. 601 KBytes)
- **Numbers** - numbers.zip (approx. 1,263 KBytes)
- **Date & Time** - time.zip (approx. 581 KBytes)
- **Telephone** - phone.zip (approx. 447 KBytes)
- **Home Automation** - home.zip (approx. 1,528 KBytes)
- **Instrumentation** - instrum.zip (approx. 1,227 KBytes)

Alphabets: English and Military

a	alpha	h	hotel	o	Oscar	v	victor
b	bravo	i	India	p	papa	w	whiskey
c	Charlie	j	Juliet	q	Quebec	x	xray
d	delta	k	kilo	r	Romeo	y	Yankee
e	echo	l	lima	s	sierra	z	Zulu
f	fox, fox trot	m	Mike	t	tango		
g	golf	n	November	u	uniform		

Numbers:

zero (4 versions)	eleven (4 versions)	ten (4 versions)	hundred
oh ** (4 versions)	twelve (4 versions)	twenty (3 versions)	thousand
one (4 versions)	thirteen (4 versions)	thirty (3 versions)	million
two (4 versions)	fourteen (4 versions)	forty (3 versions)	billion
three (4 versions)	fifteen (4 versions)	fifty (3 versions)	
four (4 versions)	sixteen (4 versions)	sixty (3 versions)	
five (4 versions)	seventeen (4 versions)	seventy (3 versions)	
six (4 versions)	eighteen (4 versions)	eighty (3 versions)	
seven (4 versions)	nineteen (4 versions)	ninety (3 versions)	
eight (4 versions)			
nine (4 versions)			

** - alternative for zero

Time and Date:

time (the)	minutes	January	Monday
is	day (the)	February	Tuesday
now	day is (the)	march	Wednesday
current time is (the)	date (the)	April	Thursday
o'clock	month (the)	may	Friday
a.m.	month is (the)	June	Saturday
p.m.	year (the)	July	Sunday
noon	year is (the)	August	
midnight	thousand	September	
second	two thousand (the year)	October	
seconds		November	
minute		December	

Telephone:

you have	dial	I will erase	hello
you have a call from	digit	all	good morning
area code	digits	no	good afternoon
number	please	the	goodbye
number is (the)	enter	thee ("the" before vowel)	thank you
	your	these	
	code	this	
	your code	this message	
	hang up	message	
	please wait	messages	
		will be erased	

Home Automation:

all	in	window	is
and	attic (the)	windows	on
the	basement (the)	blinds (the)	are on
thee (the before vowel)	bath (the)	door	off
these	bathroom (the)	front (the)	is off
appliance (the)	bedroom (the)	back (the)	is off
fan (the)	driveway (the)	up	is bright
lamp	garage (the)	down	is dim
light	Jacuzzi (the)	upstairs	is up
light (the)	kitchen (the)	downstairs	are up
lights	living room (the)	inside (the)	is down
lights (the)	master bedroom (the)	outside (the)	are down
oven (the)	playroom (the)	north (the)	is open
air conditioning (the)	pool (the)	south (the)	are open
machine (the)	porch (the)	east (the)	is closed
is running	sauna (the)	west (the)	are closed
switch	shower (the)	in zone	is less
	tennis court (the)	in zones	is more
			full
current (the)	alarm (the		is empty
temperature is	system		is locked
indoor temperature	alarm system (the)		is unlocked
heat (the)	was tripped		is ready
now	motion detector (the)		is at
degrees	there was a break in		start
Celsius	key		stop
Fahrenheit	please		
humidity is	enter		
percent	your		
thermostat (the)	code		
setting	your code		
hour	thank you		
hours			

Instrumentation:

on	current (the)	kilo	computer (the)
off	micro	mega	system
switch	milli	hertz	is down
measurement is (the)	amp	gigahertz	is ready
is	amps	pico	is running
the	volt	farads	is unlocked
thee (the before vowel)	volts	Celsius	chip
these	ohms	Fahrenheit	cable
all	kilohm	percent	connector
and	kiloohms	unit (the)	wire
please	megohms		bit
thank you	megaohms		bits
			byte
black	inch	micron	bytes
brown	inches	microns	kilobit
red	feet	centimeter	kilobits
orange	foot	centimeters	kilobyte
yellow	yard	meter	megabytes
green	yards	meters	
blue	mile	kilometer	plus
purple	miles	kilometers	minus
gray	tape (the)	gram	times
white		grams	divided by
gold	speed is (the)	pound	equals
silver	your speed is	pounds	is less
pink	per		is more
tan	per hour		than
	r.p.m.		point
	start		
	stop		
	go		

List of Vocabulary In Alphabetical Order:**A**

a (letter)
 a.m.
 air conditioning (the)
 alarm (the)
 alarm system (the)
 all
 alpha (military)
 amp
 amps
 and
 appliance (the)
 April
 are closed
 are down
 are off
 are on
 are open
 are up
 area code
 attic (the)
 August

E

e (letter)
 east (the)
 echo (military alphabet)
 eight (4 versions)
 eighteen (4 versions)
 eighty (3 versions)

eleven (4 versions)
 enter
 enter
 equals

B

b (letter)
 back (the)
 basement (the)
 bath (the)
 bathroom (the)
 bedroom (the)
 billion
 bit
 bits
 black
 blinds (the)
 blue
 bravo (military)
 brown
 byte
 bytes

F

f (letter)
 fan (the)
 farads
 Fahrenheit
 February
 feet

fifteen (4 versions)
 fifty (3 versions)
 five (4 versions)
 foot
 forty (3 versions)
 four (4 versions)
 fourteen (4 versions)
 fox (military)
 fox trot (military)
 Friday
 front (the)
 full

C

c (letter)
 cable
 Celsius
 centimeter
 centimeters
 Charlie (military)
 chip
 code
 come take
 come take your
 computer (the)
 connector
 current (the)
 current time is (the)

G

g (letter)
 garage (the)
 gigahertz
 go
 gold
 golf (military alphabet)

good afternoon
 good morning
 goodbye
 gram
 grams
 gray
 green

D

d (letter)
 date (the)
 day (the)
 day is (the)
 December
 degrees
 delta (military)
 dial
 digit
 digits
 dispense
 divided by
 door
 dose
 down
 downstairs
 driveway (the)

H

h (letter)
 hang up
 heat (the)
 hello
 hertz
 hotel (military
 alphabet)
 hour
 hours
 humidity is
 hundred

List of Vocabulary In Alphabetical Order (Continued):**I**

i (letter)
 I will erase
 in
 in zone
 in zones
 inch
 inches
 India (military)
 indoor temperature
 inside (the)
 is
 is at
 is bright
 is closed
 is dim
 is down
 is empty
 is less
 is locked
 is more
 is off
 is open
 is ready
 is running
 is unlocked
 is up
 is waiting for you to take

J

j (letter)
 Jacuzzi (the)
 January
 Juliet (military)
 July
 June

K

k (letter)
 key
 kilo
 kilo (military alphabet)
 kilobit
 kilobits
 kilobyte
 kilohm
 kilometer
 kilometers
 kilohms
 kitchen (the)

L

l (letter)
 Lamp
 Light
 light (the)
 Lights
 lights (the)
 lima (military)
 living room (the)

M

m (letter)
 machine (the)
 march
 master bedroom (the)
 may
 measurement is (the)
 medication
 medicine
 mega
 megabytes
 megahms
 megohms
 message
 messages
 meter
 meters
 micro
 micron
 microns
 midnight
 mike (military)
 mile
 miles
 milli
 million
 minus
 minute
 minutes
 Monday
 month (the)
 month is (the)
 motion detector (the)

N

n (letter)
 nine (4 versions)
 nineteen (4 versions)
 ninety (3 versions)
 no
 noon
 north (the)
 November
 November (military)
 now
 number
 number is (the)

O

o (letter)
 o'clock
 October
 off
 oh (4 ver, alt for zero)
 ohms
 on
 one (4 versions)
 orange
 Oscar (military)
 outside (the)
 oven (the)

List of Vocabulary In Alphabetical Order (Continued):**P**

p (letter)
 p.m.
 papa (military)
 per
 per hour
 percent
 percent
 pico
 pink
 playroom (the)
 please
 please
 please
 please wait
 plus
 point
 pool (the)
 porch (the)
 pound
 pounds
 purple

U

u (letter)
 uniform (mil. alphabet)
 unit (the)
 up
 upstairs

V

v (letter)
 victor (military)
 volt
 volts

Q

q (letter)
 Quebec (military)

R

r (letter)
 r.p.m.
 red
 Romeo (military)

W

w (letter)
 was tripped
 Wednesday
 west (the)
 whiskey (military)
 white
 will be at
 will be erased
 window
 windows
 wire

X

x (letter)
 xray (military)

S

s (letter)
 Saturday
 sauna (the)
 second
 seconds
 September
 setting
 seven (4 versions)
 seventeen (4 versions)
 seventy (3 versions)
 shower (the)
 sierra (military)
 silver
 six (4 versions)
 sixteen (4 versions)
 sixty (3 versions)
 south (the)
 speed is (the)
 start
 stop
 Sunday
 switch
 system

Y

y (letter)
 yankee (military)
 yard
 yards
 year (the)
 year is (the)
 yellow
 you have
 you have a call from
 your
 your code
 your medication
 your medicine
 your next
 your pill dispenser
 your speed is

T

t (letter)
 tan
 tango (military)
 tape (the)
 temperature is
 ten (4 versions)
 tennis court (the)
 than
 thank you
 the
 thee ("the" before vowel)
 there was a break in
 thermostat (the)
 these
 thirteen (4 versions)
 thirty (3 versions)
 this
 this message
 thousand
 three (4 versions)
 Thursday
 time (the)
 time for
 time for your
 times
 Tuesday
 twelve (4 versions)
 twenty (3 versions)
 two (4 versions)
 two thousand (the year)

Z

z (letter)
 zero (4 versions)
 Zulu (military)

Quadravox

Chapter 8. Error and Warning Messages

Error Message	Description and solution
Can't run several instances of dqbox	: an instance of the program is already running (dqbox codename for qv400s1)
Close current project first!	: the current project must be closed before a new one can be opened
Could not create TMP directory	: the scratch directory could not be created
Could Not Save Project	: the project could not be saved. Try saving under another name
Duplicate File, Cannot Add	: a file of the same name already exists
Error Allocating Memory	: GPF is coming!
Error launching dialog	: the dialog could not be opened: a required DLL is probably missing
Error: Cannot Add File	: the file could not be added to the project (duplicate file name?)
Error: Cannot Edit File Now	: the file is probably in use in another part of the program
Error: Concatenation must have ONE removed file for insertion	: for the special concatenation command, a "dummy" file (in the "removed" state) must be present in the current concatenation.
Error: Could not find string	: could not find the requested string in the current window
Error: No Concatenation Selected	: for certain concatenation operations, a concatenation must be selected first.
Error: No concatenation was copied	: the user tried to copy a concatenation without putting one in the copy buffere first
Error: Nothing Selected	: an operation requiring selected files was attempted without any file being selected.
Error: Null Pointer	: GPF is coming
Error: Opening File	: an attempt was made to open a non existing file.
Error: Some phrases were rejected (see .res file)	: system could not create all phrases in the "create concatenations from text" command.
Error: String contains delimiter character	: strings cannot contain the delimiter character (generally brackets), because it is used to tokenize information
Failed to lock memory for format chunk	: wave IO error message, does not bode well
Failed to lock memory for header	: wave IO error message, does not bode well
Failed to lock memory for instance data	: wave IO error message, does not bode well
Failed to open waveform input device.	: wave IO error message, does not bode well
Failed to open waveform output device	: wave IO error message, does not bode well
Failed to write block to device	: wave IO error message, does not bode well
File Already Open	: an attempt was made to open a file that is already in use by the system
Invalid DLL	: attempt to use invalid DLL for current qv400s1 software
Invalid Format, Cannot Add	: only wav files in mono, 16 bit format can be added to a project. Only certain sampling frequencies are allowed, notably 11.025 kHz and 22.050 kHz
No label entered, use CANCEL to exit dialog	: a required label was not entered, cannot continue with dialog
Not enough memory for header.	: wave IO error message, does not bode well
Not enough memory for instance data	: wave IO error message, does not bode well
Out of memory	: GPF is here!
Previous Recording Not Saved, Save it now?	: the previous recording will be erased, or added to the project, depending on the answer
Project Has Changed ! Save ?	: the system thinks that the project has changed in some way. Gives user an opportunity to save changes.

Error and Warning Messages (Continued):

Error Message	Description and solution
The waveform device can't play this format.	: attempt to play a file that the sound card cannot handle, at least according to qv400s1.
The waveform device can't record this format	: attempt to record a file a format qv400s1 does not recognize
TMP directory name must be initialized	: when installing the software, the name of the "scratch" directory must be initialized if it is not already given by default
Too Many Files Selected	: the number of files selected simultaneously to add to the project is greater than what the system can handle. Please use several installments
Unable to prepare wave header	: wave IO error message, does not bode well

Initialization File: QV400S1.ini

(Description of some parameters in the qv400s1.ini file)

```

[PROJECT]
install_dir=c:\quadravox           ;directory where software is installed
temp_dir=c:\tmp\                  ;temporary directory
punct_str=~!@#$%^&*()-_+={}|;:'"<,.>?/ ;characters ignored in concat. building from text
font_param=-13 0 0 0 400 0 0 0 0 3 2 1 1
font_name=system
LASTFILE1=C:\IQBOX\SAMPLE\SHIPIT.QSD
LASTFILE2=C:\CCVOICE4\VOICE5.QSD
LASTFILE3=F:\MGS\DQBOX\SAMPLE01.QSD
LASTFILE4=F:\QVOX\TEST\SIEMA.QSD

[WINDOW COORD]                    ;coordinates of windows used in software
main_window=44 44 571 238
concat_window=0 0 576 238
info_window=22 22 576 238
conc_column=0 116 230 341 414
column=0 50 158 216 289 337
frame_window=100 100 813 561

[AUDIO]
volume_bits=4                     ;number of bits for volume slider
device_in=0                       ;device number for recording
device_out=0                      ;device number for playback
volume_right=-12288               ;volume setting on right channel
volume_left=-16384               ;volume setting on left channel
max_recording_length=200         ;maximum recording duration, in seconds
more_info_str=3500 0 0 0 2 10 15 0 0 ;string of parameters for hardware setting
symbol_length=5.676             ;for ISDPRG04 and later cards ONLY
freq_bias=1                      ;these lines must not be used with ISDPRG02/3 boards
post_sound_duration=50          ;correction needed for certain sound cards

[QV_DLLS]                          ;information on DLLs used by software
nb_qv_dlls=1
qv_dll_name0=F:\MGS\DQBOX\ISD\WIN95\QVISDDLL.DLL

[Graphic_Display0]                ;information for file editor
Min_Max=-32767.000000 32767.000000
Scale=65536
Colors=0xff00 0xff00 0xe8ffff 0xfffff 0x0

```

Setting the Output Volume

The volume settings for the sound card are stored using 16 bit values (left justified). However, the qv400s software only allows the user to set the n most significant bits of these values (default value of n: 4). The user can change the number of significant bits by altering a line in the qv400s1.ini file (Windows 95 or later), or qv400s0.ini file, (Windows 3.11). The line is located in the [AUDIO] section of that file:

```
volume_bits=4
```

Quadravox

Chapter 9. Troubleshooting and Technical Support

We sincerely hope that you never have to read this page, but anyway, here goes:
If all else fails, you can always hit the RESET option in the main window Program... menu.

As a rule, you should first connect power to the board before you start the QV400S software, or at least before you open a project in the main window.

The green LED on the QV400D is not on or not slowly blinking when the program starts:

Check that the power supply is connected to the QV400D.

Select the RESET option in the main window Program menu. The green LED should blink briefly, then the green LED should come back on. From firmware revision M, the red and green LEDs alternate rapidly. The green LED being on indicates an "idle" condition: it is safe to remove the ISD chip from its socket. When you exit QV400S, the board is put into a sleeping state (indicated by a slowly blinking green LED), to allow pass-through of both sound card channels.

Recording does not seem to work:

Check that the audio cable from your PC sound card line output to the QV400D audio input is connected.

Check that the red LED comes on when you are sending sound to the chip. (The green LED should blink while commands are sent to the chip)

Go to the Program/Setup/Parameters Menu and set both volume values (Recording level and control level) at the maximum (15). If the unit functions with the maximum levels, they can then be adjusted back down for best quality. If the recording level is too high, the sound quality will be distorted. If it is too low, the recordings will be "noisy".

Check to see that the proper chip type is selected. If a wrong chip type has been selected, then later corrected, it may be necessary to use the Program / RESET option in the main window menu. The green LED should flash as commands are sent. If it does not, then Program / RESET should restore proper operation.

Playback does not seem to work:

Check that you have a speaker connected to the speaker output of your QV400D, or that your PC sound card speakers are connected to the MM (MultiMedia) speaker output of your QV400D

Go to the Program / Set up / Parameters and set both volume values (Recording level and Control level) at the maximum (15). If the unit functions with the maximum levels, they can then be adjusted back down for best quality. .

Check to see that the proper chip type is selected. If a wrong chip type has been selected, then later corrected, it may be necessary to use the Program / RESET option in the main window menu. The green LED should flash as commands are sent. If it does not, then Program / RESET should restore proper operation.

LEDs flash slowly, system does not respond:

From revision M, in any mode, should the red and green LEDs begin blinking slowly in any pattern except green only (which signifies lockout mode), a transmission error has occurred. The control level should be adjusted to improve the communications, but if this fails, call or email Quadravox and report the pattern of the LEDs.

There is noise on the control (usually right) channel during command operations:

Go to the Program/Set up/ Parameters menu and decrease the control volume setting. If the setting is reduced too much, the unit will stop responding to commands.

Check to see that your sound card mixer controls are set for maximum gain, and that the wave file input is enabled. Individual wave file gain settings are made automatically by the QV400S program. It is best to disable all other inputs to minimize potential noise in the control signal.

If this does not improve the problem, check the switch channels box

The recorded sounds are weak, or loud and distorted:

Go to the Program/Set up/Parameters Menu and increase (if weak) or decrease (if loud) the signal volume setting

Check to see that your sound card mixer controls are set for maximum gain, and that the wave file input is enabled. Individual wave file gain settings are made automatically by the QV400S program. It is best to disable all other inputs to minimize potential noise in the recorded signal.

If this does not improve the problem, check the Switch channels box.

Some phrases are stuck together during playback:

This may be due to the "epsilon" factors that try to compensate for the uncertainty on the ChipCorders' sampling frequency. See **epsilon**.

If all else fails, drop us a line at support@quadravox.com, describing your problem, and/or check our website for the latest troubleshooting document.

Chapter 10. Terms and Conditions

Limited Warranty

Quadravox, Inc. (Quadravox), warrants that its product will substantially conform to the performance specifications contained in the user guide (i.e. the Help Files distributed on the floppy disk shipped with the product), provided that the product is used on computer hardware and with an operating system for which it was designed. In the event of any defects in manufacture or failure to conform to published specifications, Quadravox will, at its option, repair or replace defective product at no charge. Defective product must be received at Quadravox facility within one year from date of purchase, accompanied by proof of purchase. Shipping charges to Quadravox shall be prepaid by the purchaser.

The foregoing warranty is exclusive and in lieu of all other warranties, express or implied, including but not limited to implied warranty of merchantability or fitness for a particular purpose. Quadravox expressly disclaims any and all liability for any incidental, special, or consequential damages arising from the use or inability to use its product, software, or documentation. In no case shall the liability of Quadravox exceed the cost of the product.

Some states do not allow the limitation or exclusion of implied warranties or general liability, so the above limitation or exclusion may not apply or may itself be limited, solely by operation of the law.

If merchandise is damaged in transit, please contact Quadravox immediately.

Quadravox warranty does not apply to products, which have been subject to misuse (including static discharge), neglect, accident, or modification.

For returns other than defective products (i.e., not covered by warranty), the product:

- must be returned to Quadravox within 15 days from the date of invoice
- must accompany the original invoice.
- must be in re-saleable condition.

Any deviation of the above will require Quadravox approval.

A brief note explaining the reason for return is also required.

Quadravox's only obligation for products that prove to be defective within 90 days of purchase will be to replace the product (free of charge) or refund. Quadravox does not give any warranty, either expressed or implied and specifically disclaims all other warranties, including warranties for merchantability of customer's products designed or built using any of QV products. QV's liability will be limited to buyer's purchase price. Quadravox will not be liable for any indirect or consequential damages.

Quadravox products are not approved for use as critical components in life support devices or systems. Do not use Quadravox products as critical component of a life support device or system. Quadravox can not be held liable for any damaged caused by failure of Quadravox product under these circumstances.

Software License Agreement

Quadravox grants the user a license to install the software on multiple computers. The user may make back-up copies to guard against loss, may loan the software to others (subject to the prohibition of use on more than one computer at a time), and may transfer the software and hardware on a permanent basis to another individual.

Disclaimer and Copyright Notice

Information in the accompanying software and documentation has been checked and is deemed to be accurate; however, Quadravox, Inc. claims no responsibility for inaccuracies contained within. The information contained in these documents may also change without notice. No part of the software or documentation may be copied, reproduced, transmitted, transcribed, stored in a retrieval system, or translated to another language for other than the purpose of personal use without the prior, written permission of Quadravox, Inc. or its associates.

Quadravox

Appendix A. Worldwide Distributors

Worldwide Distributor List

Central America, South America and Caribbean

Ibars Electronics Corp
10020 N.W. 6th Court
Pembroke Pines, FL 33024
USA
Tel : (954) 430-3740
Fax : (954) 430-3763
email : information@ibars.com
web site : <http://www.ibars.com>

Argentina

Cika Electronica SRL
Av de Los Incas 4821
(1427) Buenos Aires
Argentina

Tel : 54-11-45225466
Fax : 54-11-45236068
Email : cika@cika.com

Israel

El-Gev Electronics Ltd.
11, Ha-avoda Street, POB 248
Rosh Ha-ayin, 48107,
Israel
Tel : 972-3-902-7202
Fax : 972-3-902-7203
Email : sales@elgev.co.il
web site : <http://www.elgev.co.il>

Korea

ENC Korea Ltd
110-3 Dangjeong-Dong
Kunpo-Si, Kyungski-do,
Korea
Tel : 82-343-51-2220
Fax : 82-343-57-2345

U.S. Office :

Ellen & Company, Inc (ENC)
13620 Cimarron Avenue
Gardena, CA 90060, U.S.A
Tel : 310-366-1314
Fax : 310-366-1319

Australia and New Zealand

Adilam Electronics Pty. Ltd
14 Nicole Close
Nth Bayswater, Victoria 3153
Australia
Tel : (613) 9761-4466
Fax : (613) 9761-4161
email : adilam@adilam.com
web site : <http://www.adilam.com.au>

Brazil

Cika Eletronica Do Brasil Ltda.
Rua Belo Horizonte, 102
Vila Pari, CEP 03052-040
Sao Paulo, SP,
Brazil
Tel : (55-11) 6693-6428
Fax : (55-11) 6693-8805
Email : lkwok@cika.com.br

Italy

Silverstar Ltd. S.P.A
Viale Fulvio Testi, 280
20126 Milano
Italy
Tel : 39-2-661-251
Fax : 39-2-661-01359

United Kingdom

Sequoia Tekelek Europe
Teklek House,
Back Lane, Spencers Wood,
Reading Berks,
U.K. RG7 1PW
Tel : +44 1189 258 080
Fax : +44 1189 258 020

Taiwan

Prospect Technology Corporation
1 st Floor, No. 34, Chu Luen Street
Taipei, taiwan R.O.C.
Tel : 886-2-27219533
Fax : 886-2-87710822 & 27733756
Email : roger_hou@prospect.com.tw

Worldwide Distributor List (continued)

France

A2M / Tekelec

5 Rue Carle Vernet

92315 Sevres Cedex, France

Tel : 33-1-46-23-79-54

Fax : 33-1-46-23-79-27

Email : cpompon@tekelec.fr

Quadravox, Inc.

1701 N. Greenville Ave., Suite 608
Richardson, TX, 75081
USA

Tel: 1-800-779-1909 or 1-972-669-4002

Fax: 1-800-371-9891 or 1-972-437-6382

email: info@quadravox.com

Web site: www.quadravox.com